

# INOVATION SILKE

120X90X210 SORT, 8MM

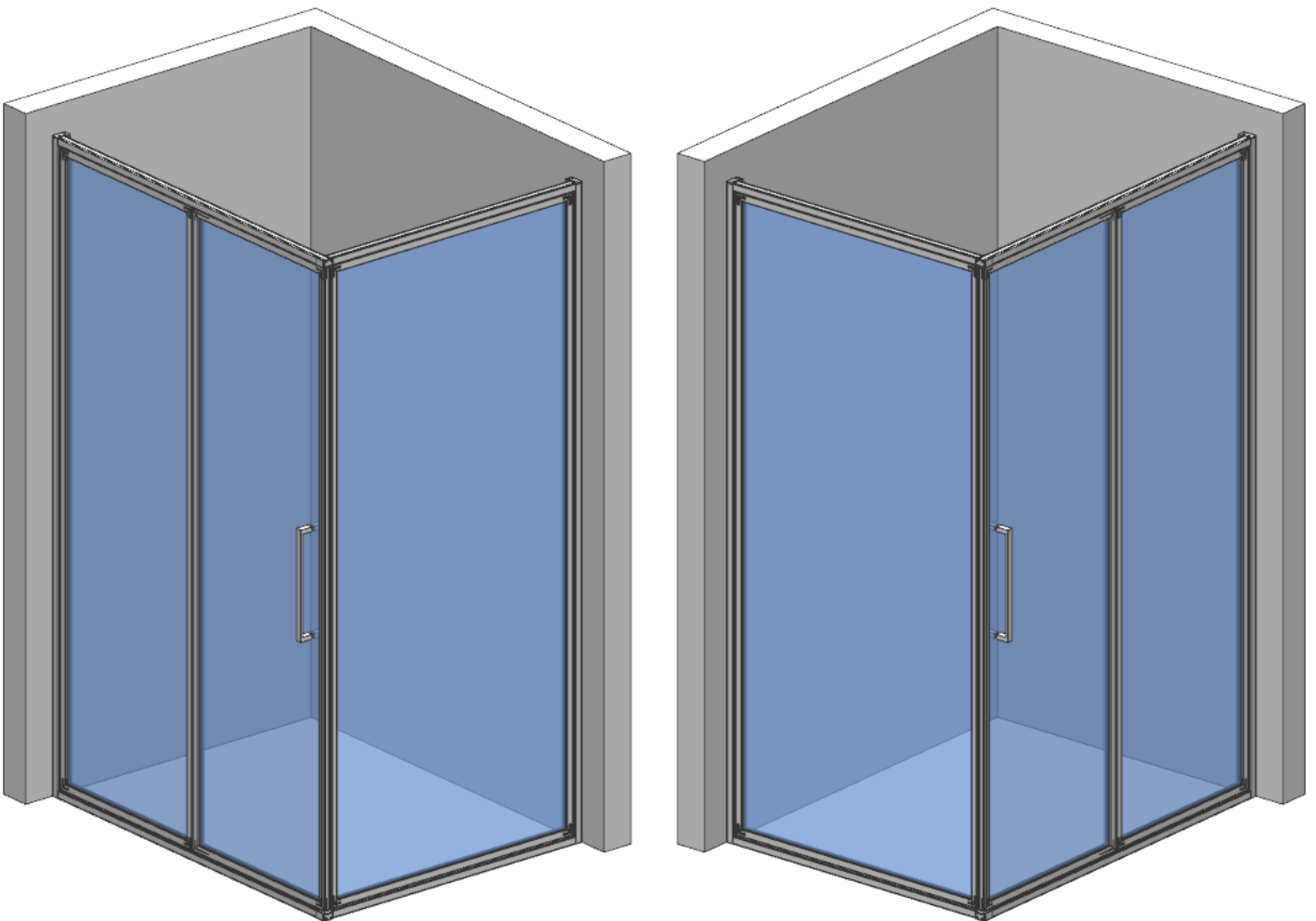



## **Vi takker for ditt valg av en Celeste dusjløsning.**

**Før du setter i gang med monteringen av dette produktet er det viktig at du får oversikt over alle delene. Bruk god tid til å sette deg inn i hvordan monteringen skal utføres.**

Det kan være en fordel og være to personer under monteringen. Husk og sjekke at alle glassflater er hele og at folien ikke har noen riper før du starter monteringen. Dersom du skulle oppdage ripe i folien før monteringen finner sted må dette meldes ifra til oss umiddelbart. Garantien på skadet folie på montert produkt, er inntil 3 måneder etter kjøpsdato

### **Viktig å tenke på ved montering av herdet glass med folie:**

- 1) Skadet glass må under ingen omstendigheter monteres ettersom sikkerhetsfunksjonen bygger på at glasset er 100% intakt under montering. Kontroller derfor at hvert glassfelt er i uskadet tilstand før det monteres. Kontroller hjørnene ekstra nøye.
- 2) Beskytt alltid glasskantene mot skader og slag under monteringsarbeidet. Se til at glasset og at hjørnene ikke støter imot ståldetaljer, murverk, vegg- og gulvfliser eller andre harde flater ved montering og bruk.
- 3) Sett aldri en glassflate på glassets hjørnekant.
- 4) Glassflatene har en transparent beskyttelsesfolie på utsiden. Sørg for at glassflatene alltid monteres med folien på utsiden. Siden folien er festet på utsiden av glassflaten er den utsatt for riper, risp og slag under montering. Vær derfor nøye med at ingen harde gjenstander kommer i kontakt med glasset, eller at glassflaten legges ned på et hardt underlag som kan forårsake riper.

### **Tips:**

- Oppbevar glasset i forpakningen helt til det skal monteres.
- Sett aldri glasset direkte ned på gulvflisene eller lignende harde underlag .
- Det kan være en fordel å være to personer under monteringen.

### **Vedlikehold av dusj**

Profiler er av krom eller pulverlakkert aluminium og dører av herdet sikkerhetsglass med en folie på innsiden. Dusjen rengjøres på vanlig måte. Gjør rent ofte og bruk vanlige rengjøringsmidler som Plumbo clean bad og dusjrens eller Jif baderom.

Unngå bruk av stålull og fibersvamp, samt rengjøringsmidler med skurekorn, da dette kan ripe profilene og folien på utsiden av glasset. Unngå bruk av saltsyre, svovelsyre og kaustisk soda. Løsemidler som aceton eller trikloretylen er også skadelig ved rengjøring.

Sørg for god ventilasjon i rommet. Bruk f.eks. en baderomsvifte eller lufte ofte for å hindre at det dannes kondens og muggsopp.profilene og folien på utsiden av glasset.

Unngå bruk av saltsyre, svovelsyre og kaustisk soda. Løsemidler som aceton eller trikloretylen er også skadelig ved rengjøring. Sørg for god ventilasjon i rommet. Bruk f.eks. en baderomsvifte eller lufte ofte for a hindre at det dannes kondens og muggsopp.

### **Lykke til med monteringen!**



## **Vi tackar dig för att du har valt en Celeste duschlösning.**

**Innan du börjar installera denna produkten är det viktigt att du får en överblick över alla delar. Använd god tid till att bekanta dig med hur installationen måste utföras.**

Det kan vara en fördel att vara två personer under montering. Kom ihåg och kontrollera att alla glasytorna är hela och att folien inte har några repor innan installationen startas. Vänligen kontakta oss om du hittar eventuella repor och skador före installationen. Garantin på skadad folie på den monterade produkten är upp till 3 månader efter inköpsdatumet

### **Viktigt att tänka på vid installation av härdat glas med folie:**

- 1) Skadat glas får under inga omständigheter monteras eter som säkerhetsfunktionen bygger på att glaset är 100% intakt under installationen. Var därför säker på att varje glasfält är oskadat innan det monteras. Kontrollera hörnen extra noggrant.
- 2) Skydda alltid glasskanterna mot skador och slag under monteringsarbetet. Se till att glaset och hörnen inte möter ståldetaljer, betong-, vägg- och golvplattor eller andra hårda ytor under installationen.
- 3) Placera aldrig en glasyta på glasets hörnkant.
- 4) Glaset har en genomskinlig skyddsfilm på utsidan. Se till att glasytorna alltid är monterade med folien på utsidan. Eftersom folien är fäst på utsidan av glasytan är den utsatt för repor och stötar under installationen. Se till att inga hårda föremål kommer i kontakt med glaset eller att glasytan läggs ner på en hård yta som kan orsaka repor.

### **Tips:**

- Bevara glaset i förpackningen tills produkten skall monteras
- Placera aldrig glaset direkt på golvplattorna eller liknande hårda ytor.
- Det är en fördel att vara två personer under installationen.

### **Duschunderhåll**

Profiler tillverkas i krom eller pulverlackerad aluminium och dörrar av härdat säkerhetsglas med folie inuti. Duschen rengörs på vanligt vis. Rengör ofta och använd vanliga rengöringsmedel.

Undvik att använda stålull och fiber svamp och rengöringsmedel med skrubbande korn. Detta kan repa profilerna och folien på utsidan av glaset. Undvik att använda saltsyra, svavelsyra och kaustik soda. Lösningemedel som aceton är också skadligt vid rengöring.

Använd bra ventilation i rummet. Använd t.ex. en badrumsfläkt och ventiler ofta för att förhindra kondens och att svamp bildas på folien på utsidan av glaset.

### **Lycka till med monteringen!**



### **Dziękujemy za wybór rozwiązania prysznicowego Celeste.**

**Przed rozpoczęciem instalacji tego produktu ważne jest, aby uzyskać przegląd wszystkich części. Poświęć dużo czasu na zapoznanie się ze sposobem montażu.**

Może to być zaletą montaż z dwiema osobami podczas montażu. Zapamiętaj i sprawdź, czy wszystkie szklane powierzchnie są pełne i czy folia nie ma żadnych zadrapań przed rozpoczęciem instalacji. Jeśli zauważysz zadrapania w folii przed rozpoczęciem instalacji, należy to natychmiast zgłosić. Gwarancja na uszkodzoną folię na zmontowanym produkcie wynosi do 3 miesięcy od daty zakupu

### **Ważne do rozważenia przy dopasowywaniu szkła hartowanego za pomocą folii:**

- 1) W żadnym wypadku nie należy montować uszkodzonego szkła, ponieważ funkcja bezpieczeństwa opiera się na tym, że szkło jest nienaruszone w 100% podczas montażu. Dlatego przed montażem upewnij się, że każde pole szklane jest w nienaruszonym stanie. Dokładnie sprawdź rogi.
- 2) Zawsze należy chronić krawędzie szkła przed uszkodzeniem i uderzeniem podczas montażu. Upewnij się, że szkło i narożniki nie napotykają stalowych detali, kamieni, płytek ściennych i podłogowych lub innych twardych powierzchni podczas instalacji i użytkowania.
- 3) Nigdy nie stawiaj szklanej powierzchni na krawędzi narożnej szyby.
- 4) Powierzchnie szklane mają na zewnątrz przezroczystą folię ochronną. Upewnij się, że szklane powierzchnie zawsze mają folię na zewnątrz. Ponieważ folia jest przymocowana do zewnętrznej powierzchni szyby, podczas montażu narażona jest na zarysowania, zarysowania i uderzenia. Dlatego należy upewnić się, że żadne twarde przedmioty nie stykają się ze szkłem lub że powierzchnia szkła osiada na twardej powierzchni, która może powodować zarysowania.

### **Wskazówki:**

- Trzymaj szkło w opakowaniu, dopóki nie zostanie zamontowane.
- Nigdy nie stawiaj szkła bezpośrednio na płytkach podłogowych lub podobnych twardych powierzchniach.

### **Konserwacja prysznic**

Profile wykonane są z aluminium pokrytego chromem lub proszkiem oraz drzwi z hartowanego szkła bezpiecznego z wewnętrzną folią. Prysznic jest czyszczony w zwykły sposób. Czyść często i używaj zwykłych środków czyszczących, do łazienek i prysznicu np. Plumbo, JIF.

Unikaj stosowania wełny stalowej i gąbki z włóknem, a także środków czyszczących z systemem szorowania, ponieważ może to zarysować profile i folię na zewnętrznej stronie szkła. Unikaj stosowania kwasu solnego, kwasu siarkowego i sody kaustycznej. Rozpuszczalniki takie jak aceton lub trichloroetylen również są szkodliwe w czyszczeniu.

Zapewnij dobrą wentylację w pomieszczeniu. Używaj np. często wentylator lub odpowietrznik, aby zapobiec kondensacji i pleśni na zewnątrz szkła.

### **Powodzenia w montażu.**



**We thank you for choosing a Celeste shower solution.**

**Before starting the installation of this product, it is important that you get an overview of all parts. Take good time to read the manual carefully**

Two people are recommended during assembly. Remember and check that all glass surfaces are full and that the foil does not have any scratches before starting installation. Please report it as soon as you notice any scratches and damage before installation. The warranty on damaged foil on the assembled product is up to 3 months after the date of purchase

**Important to consider when installing tempered glass with foil:**

1) Under no circumstances should damaged glass be fitted as the safety function is based on the glass being 100% intact during installation. Therefore, make sure each glass field is intact condition before mounting. Check the corners extra careful.

2) Always protect the glass edges against damage and impact during assembly. Make sure the glass and the corners do not encounter steel details, concrete, wall and floor tiles, or other hard surfaces during installation.

3) Never place a glass surface on the corner edge of the glass.

4) The glass surfaces have a transparent protective film on the outside. Make sure the glass surfaces are always fitted with the foil on the outside. Since the foil is attached to the outside of the glass surface, it is exposed to scratches, scratches and impacts during assembly. Therefore, make sure that no hard objects come into contact with the glass or that the glass surface is deposited on a hard surface that can cause scratches.

**Tips:**

- Keep the glass in the package until the product is mounted
- • Never place the glass directly on the floor tiles or similar hard surfaces.
- It is an advantage to be two people during installation.

**Shower maintenance**

Profiles are made of chrome or powder-coated aluminum and doors of hardened safety glass with a foil on the inside. Clean often and use regular cleaning products such as the Plumbo clean bad og dusjrens or Jif baderom.

Avoid the use of steel wool and fiber sponge, as well as cleaning agents with scrubbing grain, as this can scratch the profiles and foil on the outside of the glass. Avoid using hydrochloric acid, sulfuric acid and caustic soda.

Provide good ventilation in the room. Use the bathroom fan or vent frequently to prevent condensation and molds from forming on the outside of the glass.

**Good luck with the mounting.**

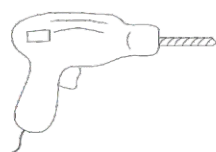
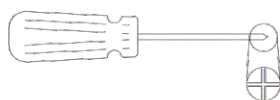
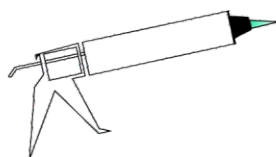
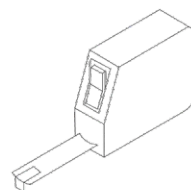
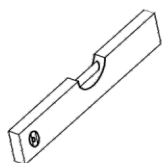

Ø6

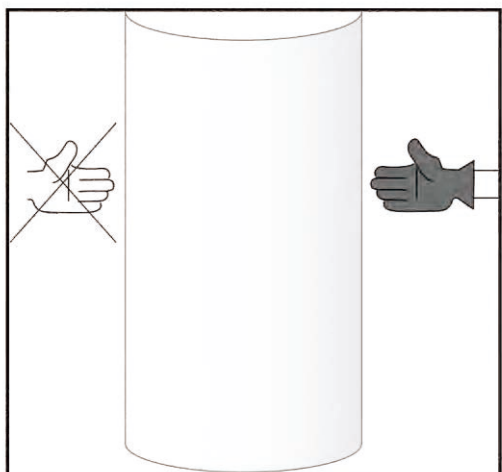

- NO** Benytt hansker ved håndtering av glass
- SE** Använd handskar när du hanterar glas
- PL** Nosić rękawice podczas pracy ze szkłem
- GB** Wear gloves when handling glass

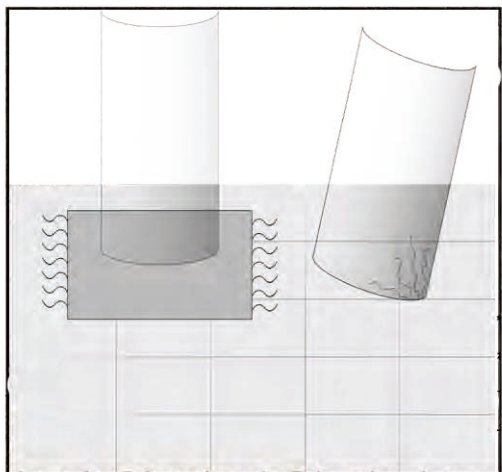

- NO** Sett aldri glass direkte på gulv
- SE** Placera aldrig glas direkt på golvet
- PL** Nigdy nie stawiaj szkła bezpośrednio na podłodze
- GB** Never place glass directly on the floor

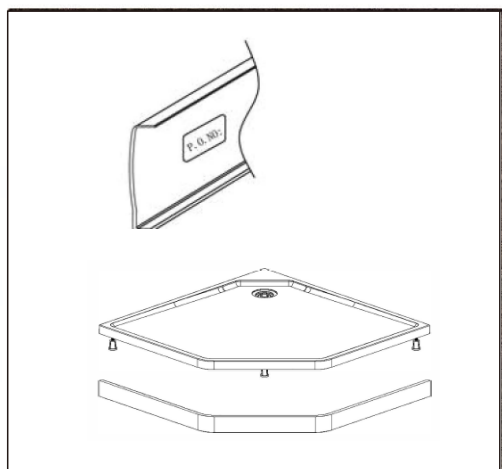

- NO** Servicenummeret er plassert på baksiden av bunndekselet
- SE** Servicenummeret är placerat på baksidan av bottenkåpan
- PL** Numer serwisowy znajduje się z tyłu dolnej pokrywy
- GB** The service number is located on the back of the bottom cover



- NO** viktig å tenke på ved montering av herdet glass med folie.
- SE** viktigt att tänka på vid installation av härdat glas med folie.
- PL** ważne do rozważenia przy dopasowywaniu szkła hartowanego za pomocą folii.
- GB** Important to consider when installing tempered glass with foil.



- NO** Ikke benytt skarpe gjenstander mot glassoverflaten.
- SE** Använd inte skarpa föremål mot glasytan.
- PL** Nie używaj ostrych przedmiotów przedmioty na szklaną powierzchnię.
- GB** Do not use sharp objects against the glass surface.



- NO** ikke benytt sterke rengjøringsmidler mot glassoverflaten
- SE** Använd inte starkt rengöringsmedel mot glasytan
- PL** Nie używaj silnych środków czyszczące na szklaną powierzchnię
- GB** Do not use strong cleaning products against the glass surface

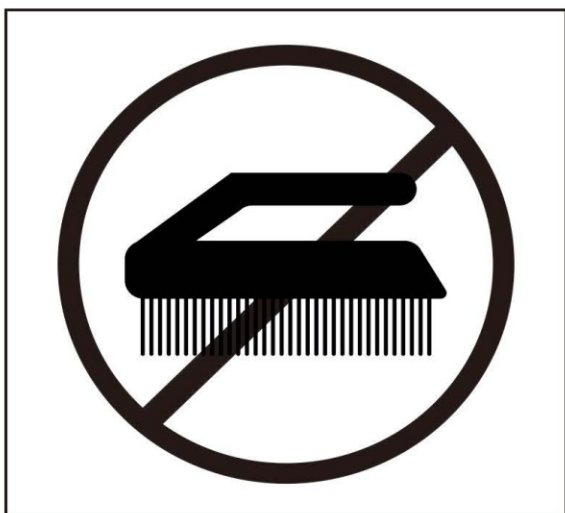

- NO** Ikke benytt skureartikler mot glassoverflaten. Rengjør med klut.
- SE** Inte använda skureartikler mot glasöverflatan. Rengör med tyg
- PL** Nie używaj elementów szorujących na szklaną powierzchnię. Oczyszć szmatką
- GB** Don't use scrubbing items against the glass surface. Clean with cloth





# Forsiktig!

Still aldri glassdøren direkte på gulvet

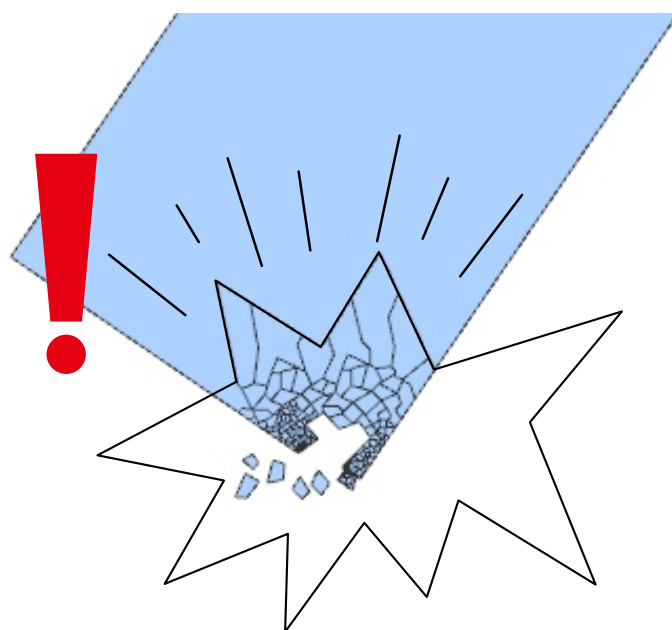
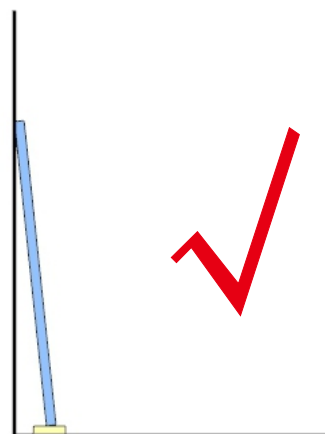
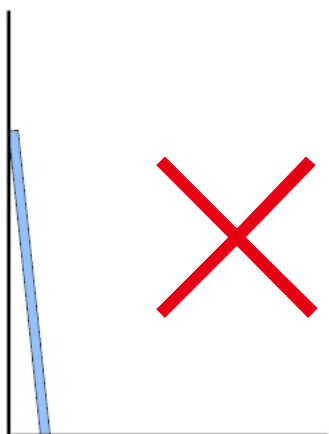

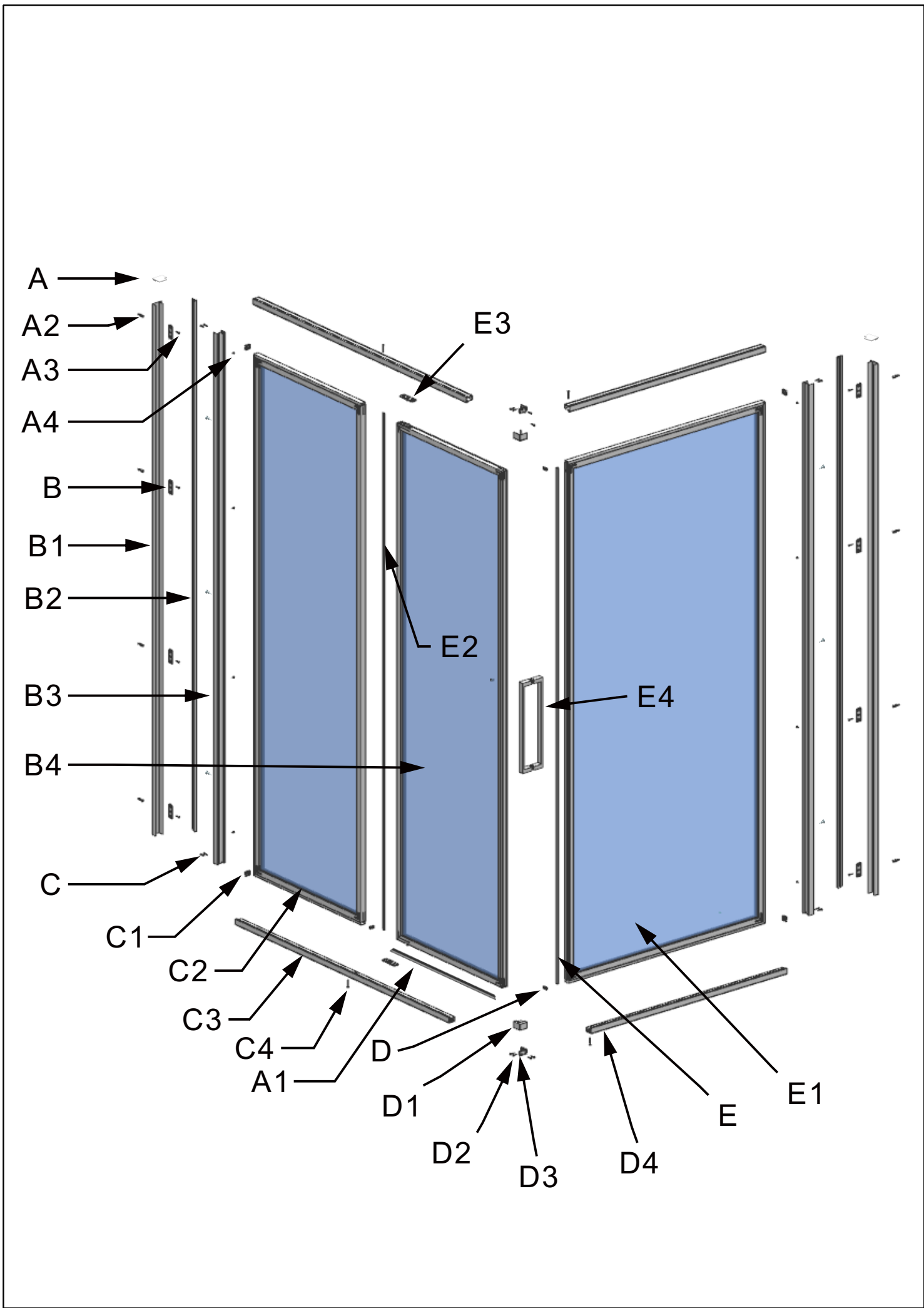

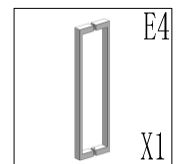
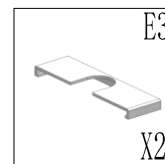
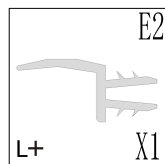
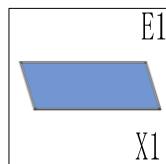
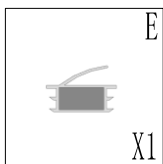
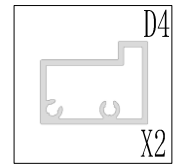
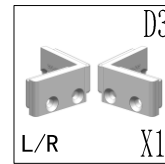
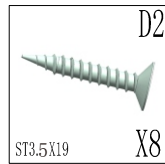
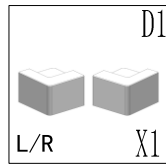
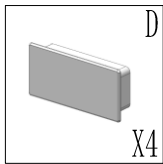
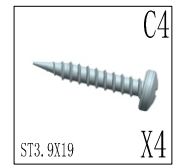
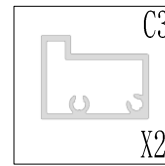
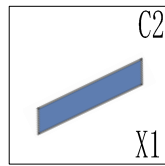
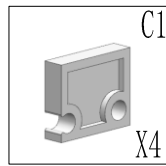
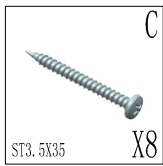
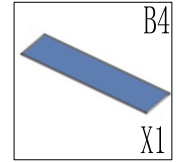
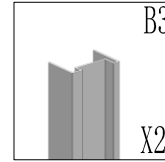
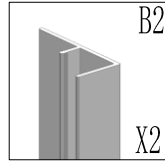
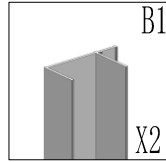
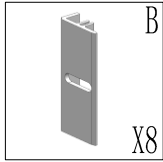
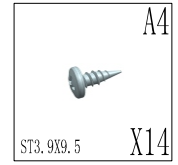
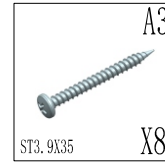
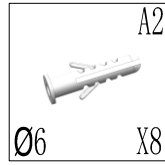
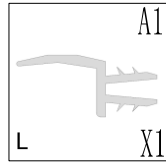
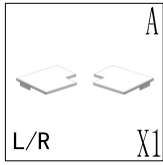

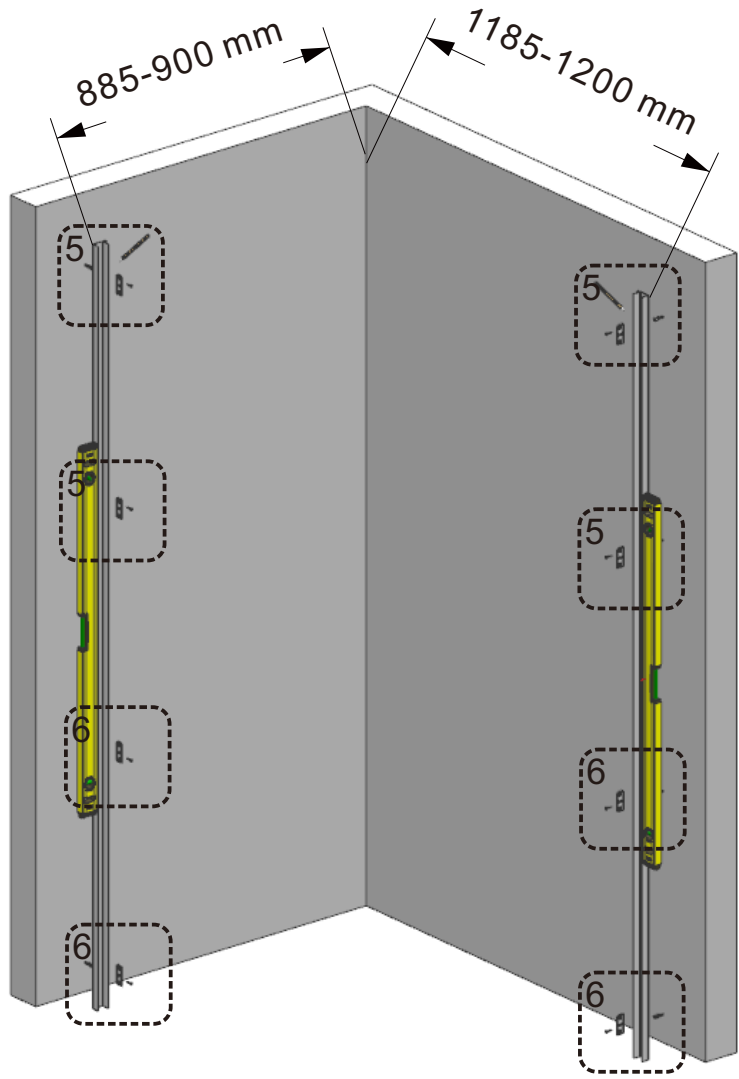
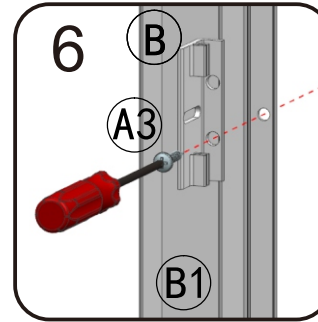
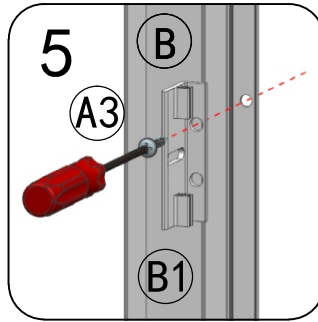
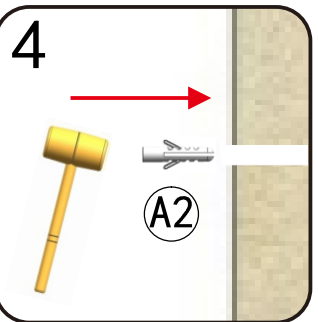
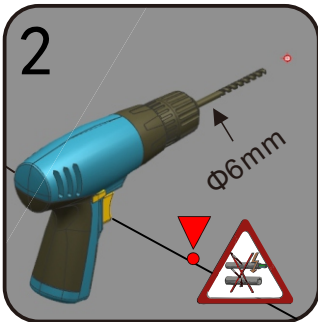
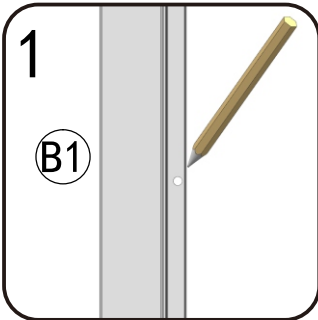
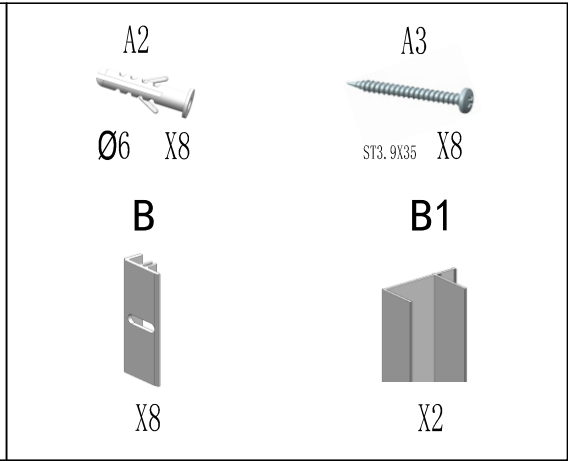
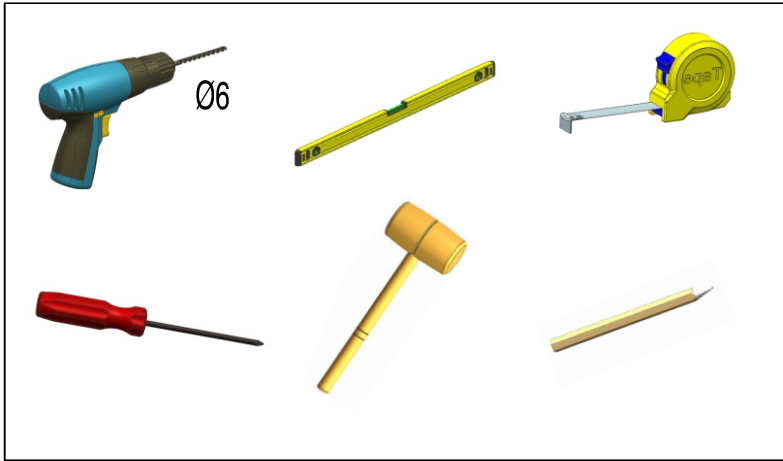

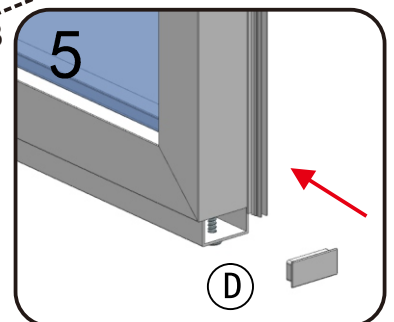
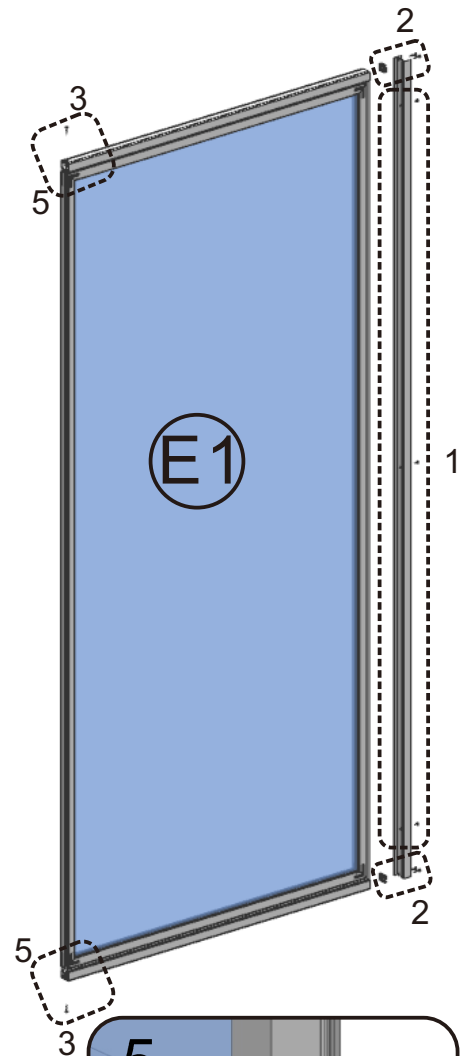
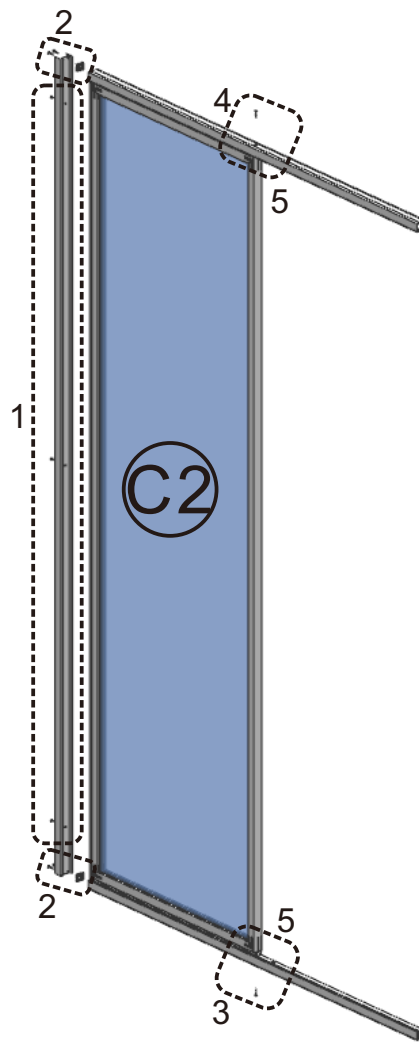
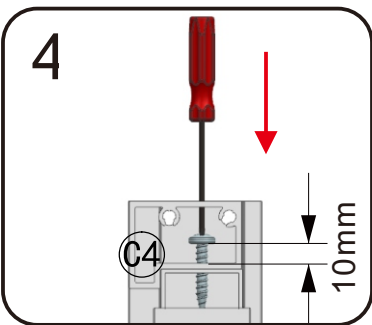
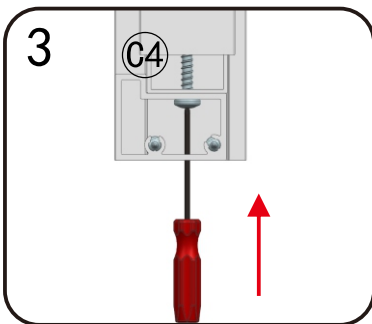
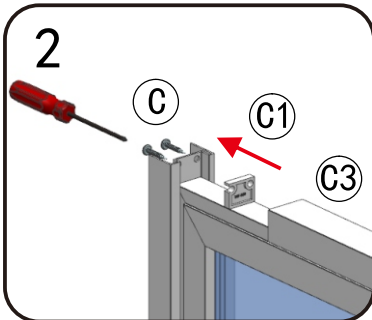
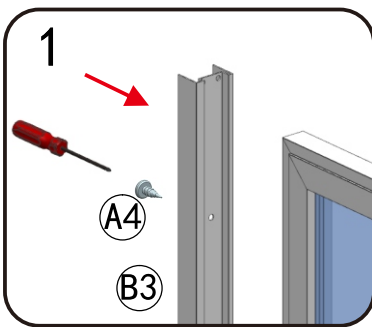
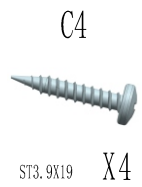
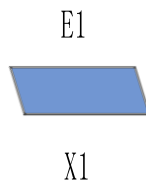
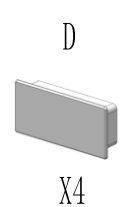
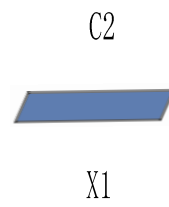



Ø2.8

A4



ST3. 9X9.5 X8

B2



X2

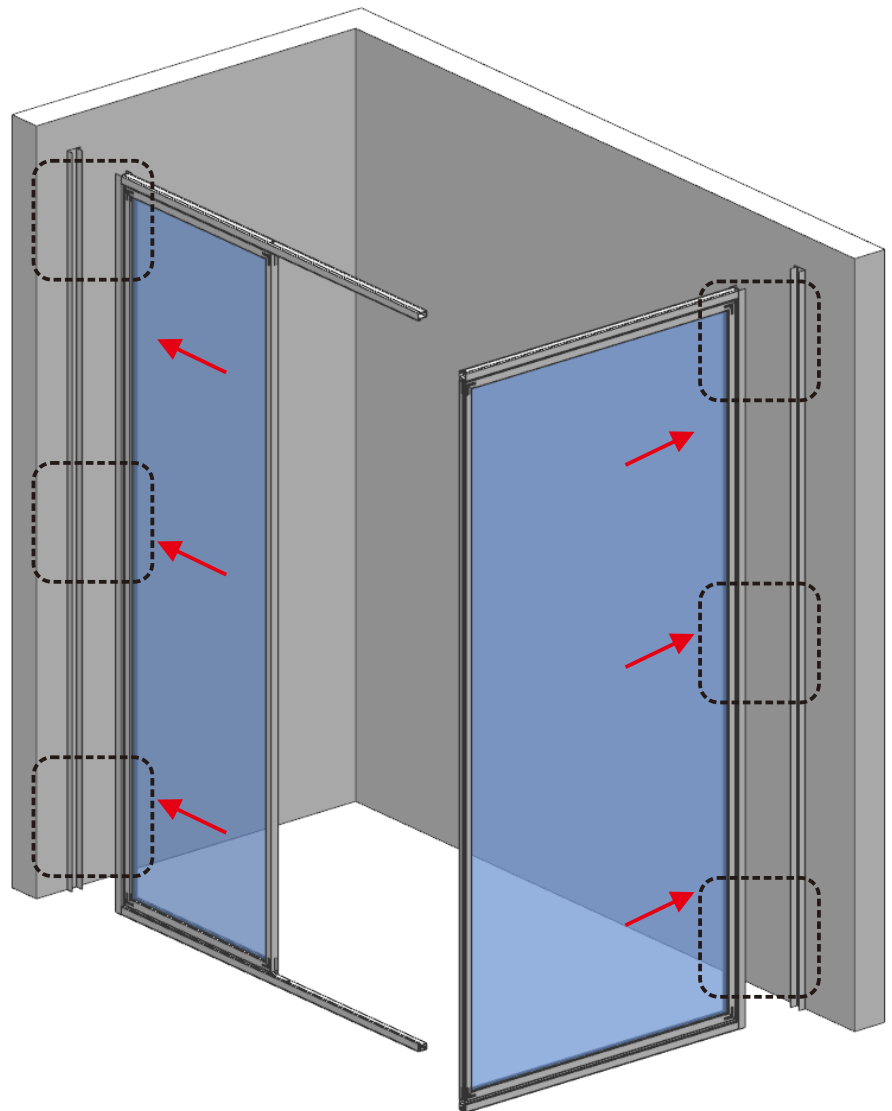
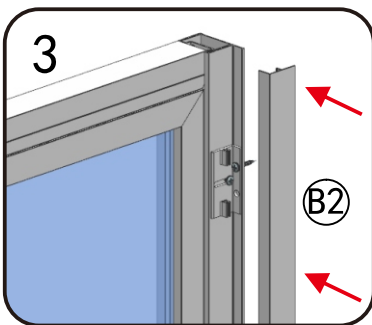
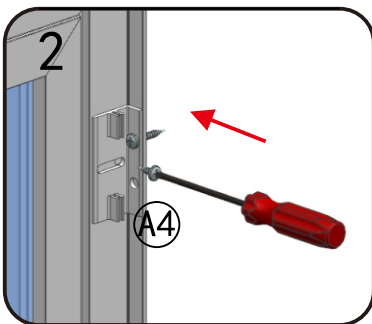
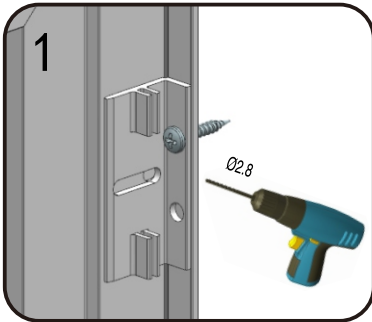

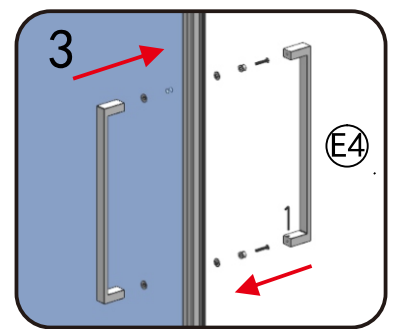
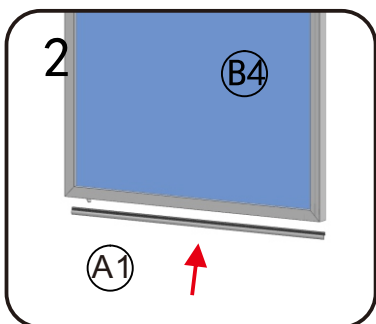
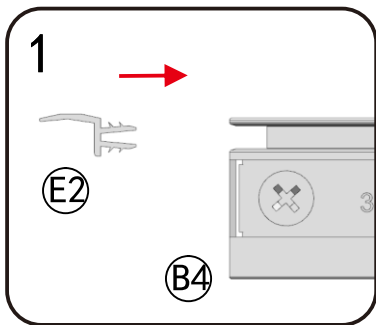
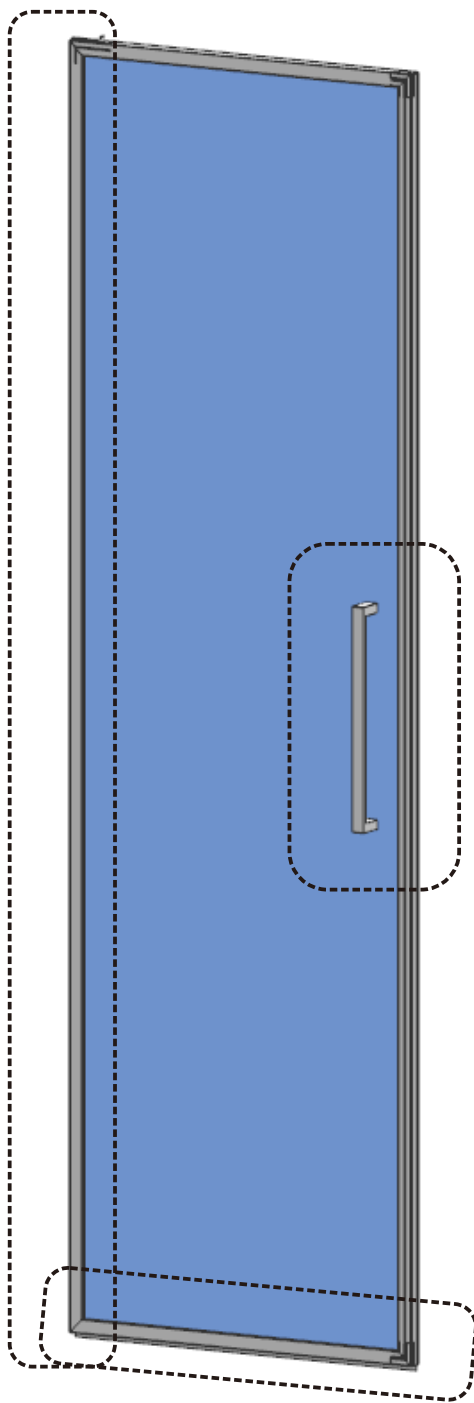
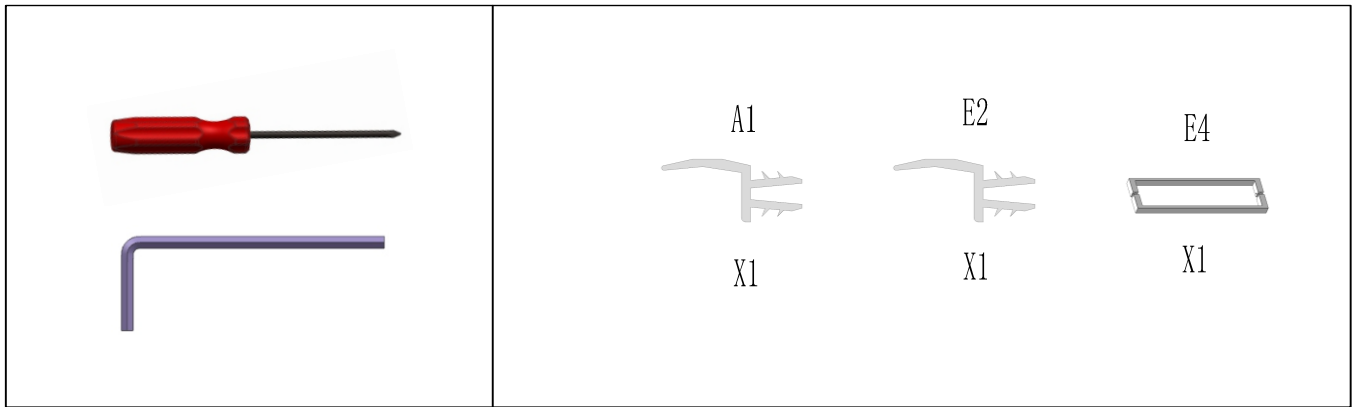

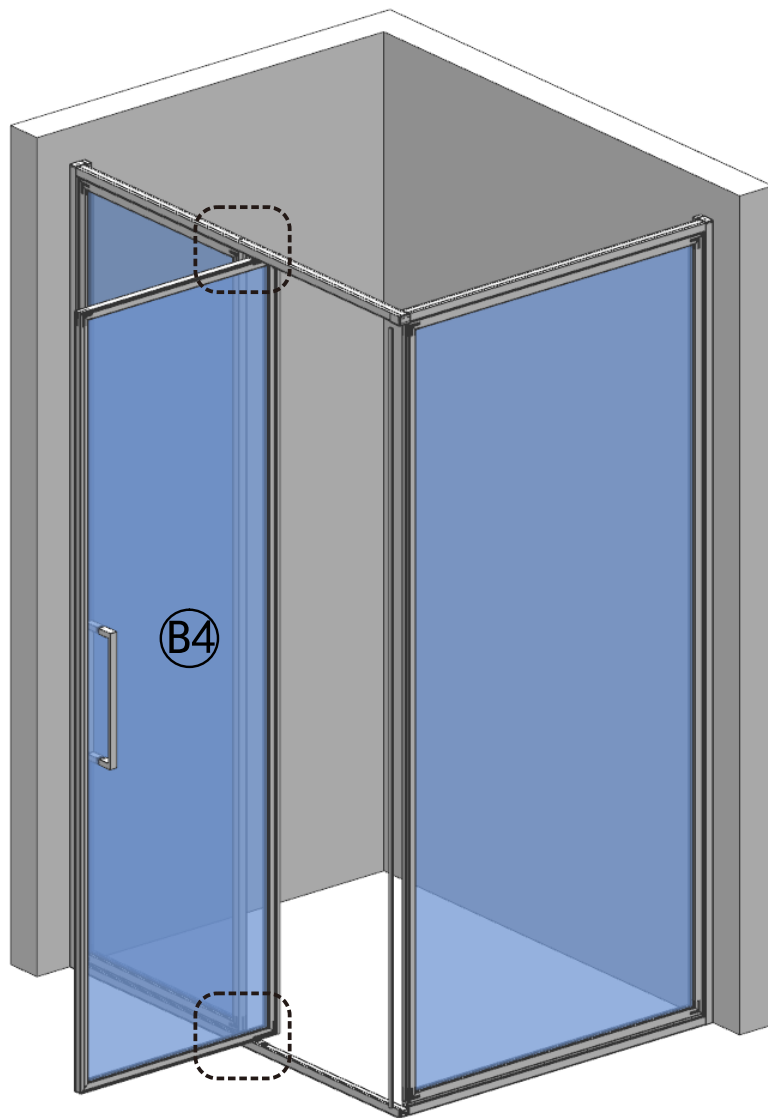
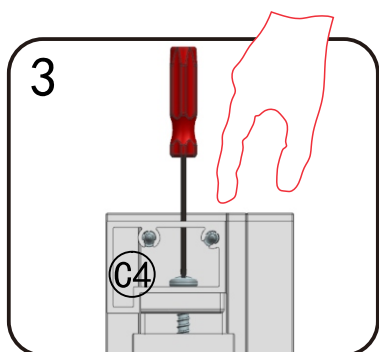
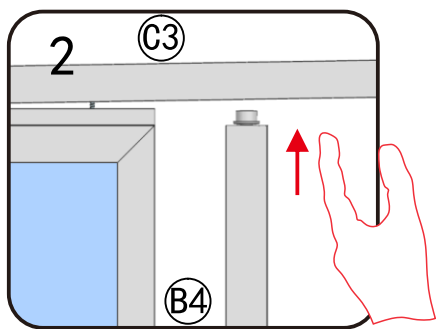
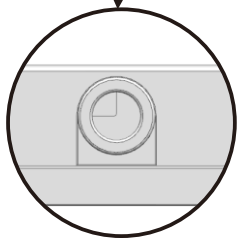
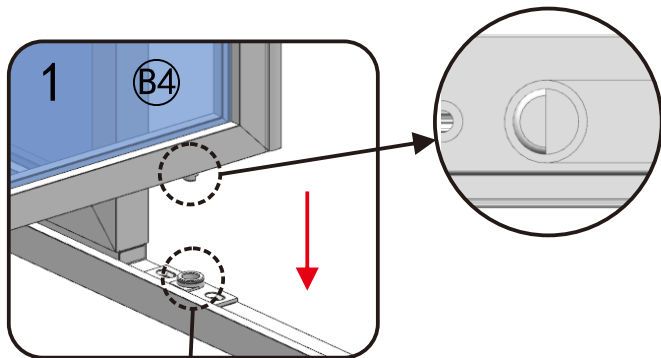
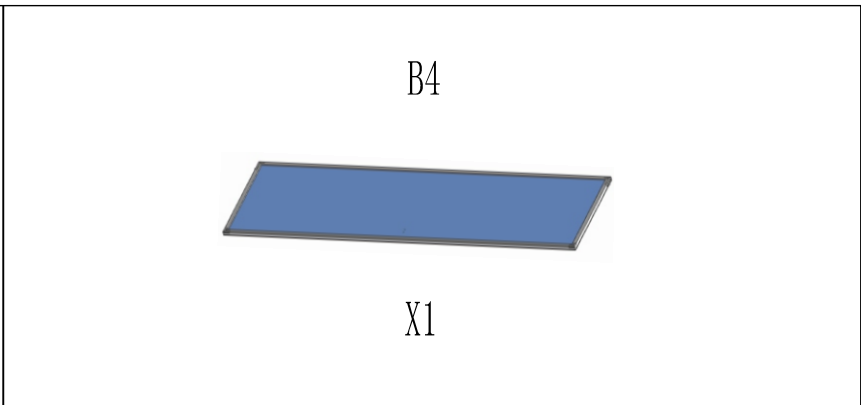



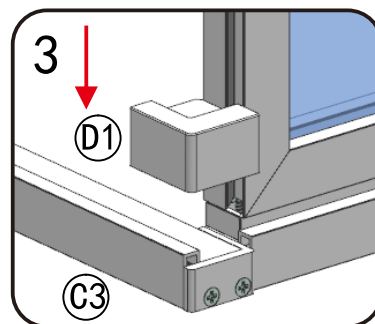
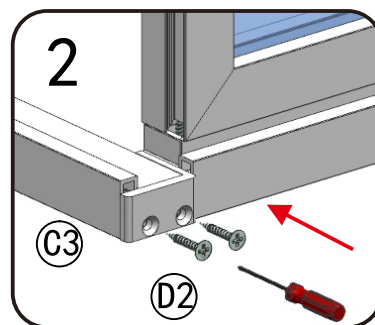
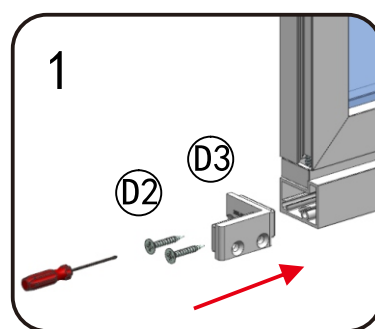
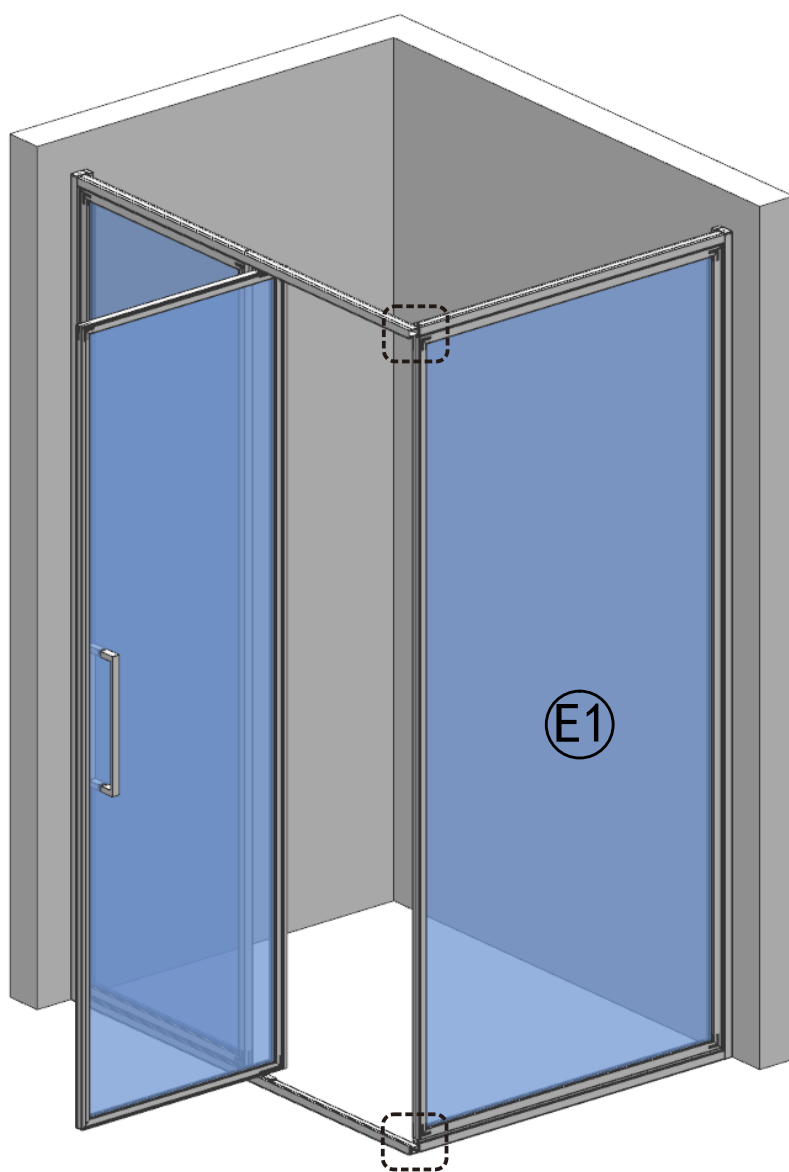
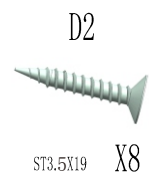
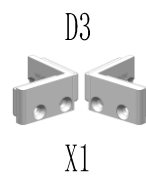
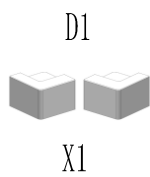

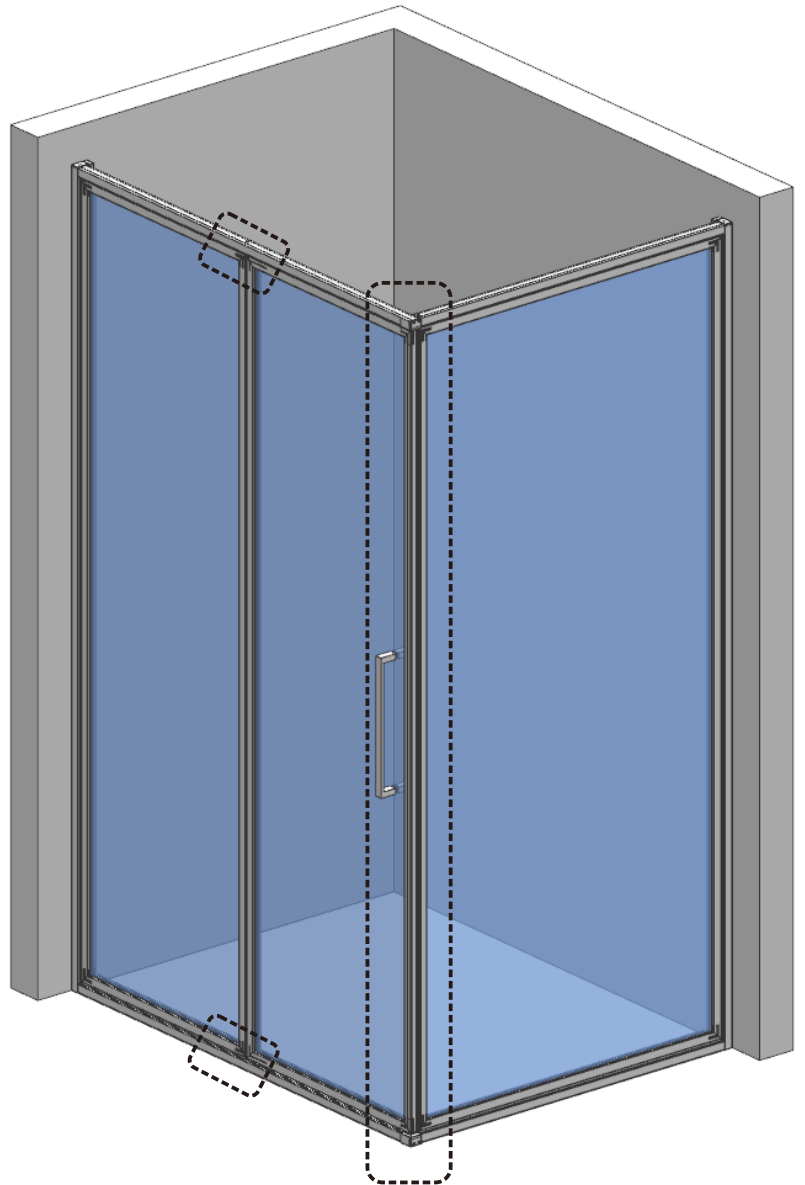
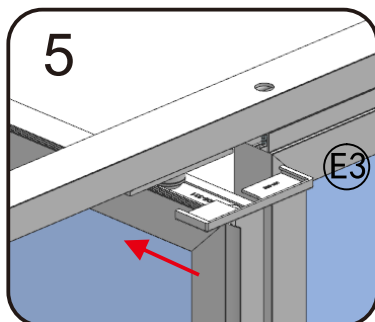
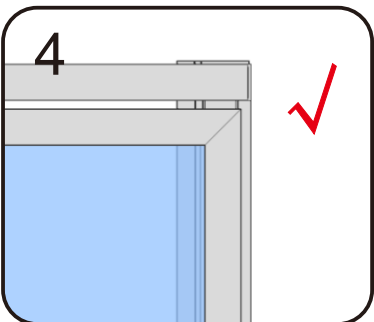
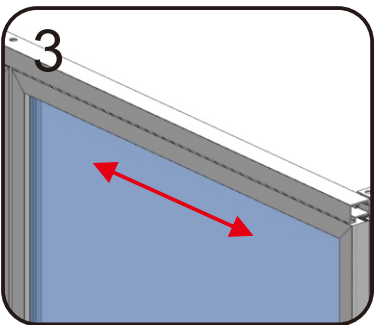
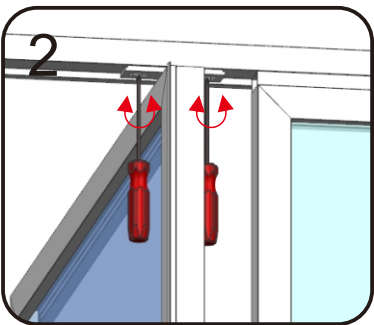
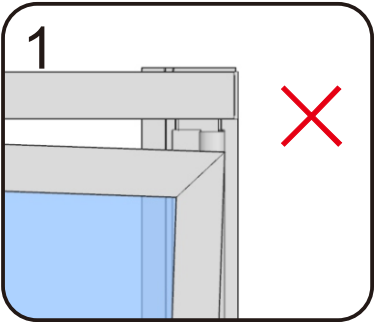
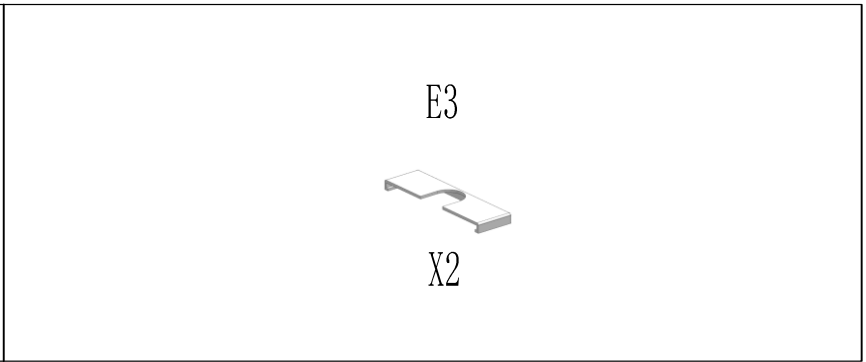

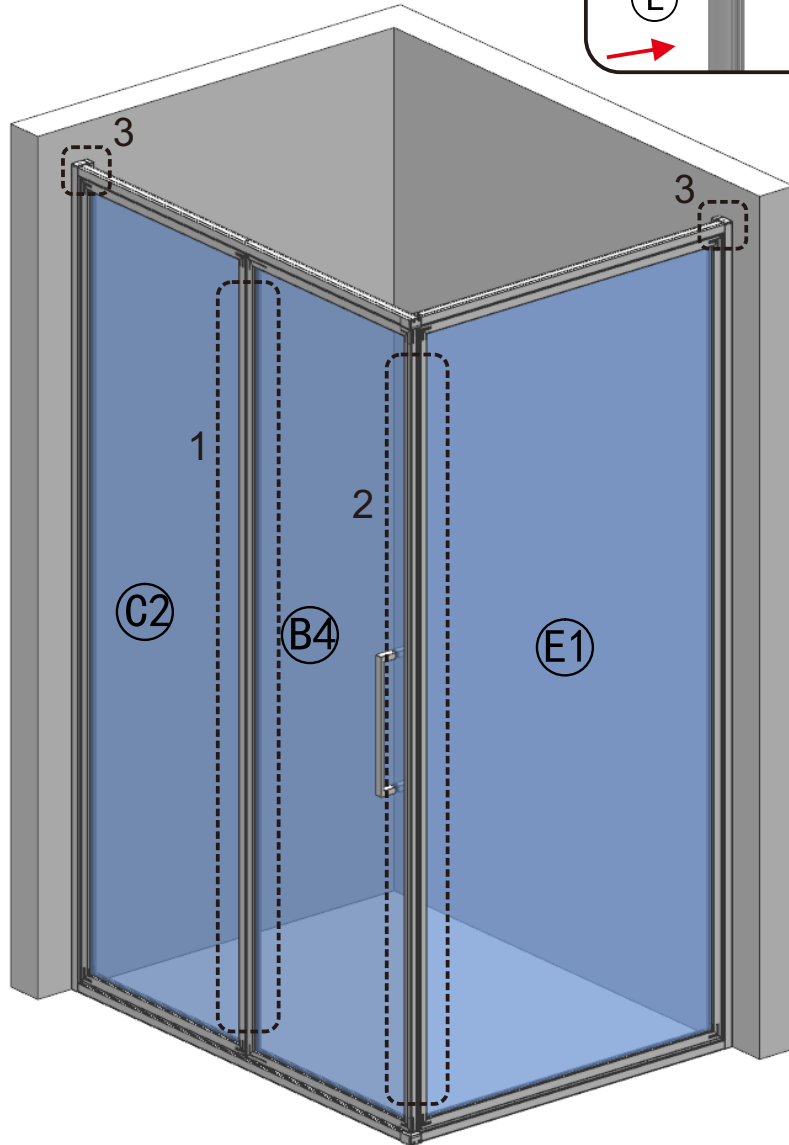
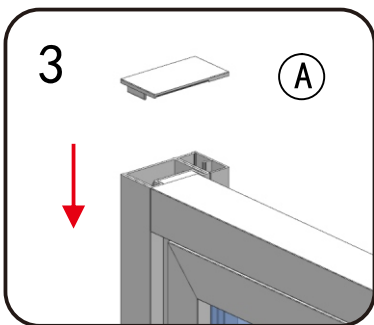
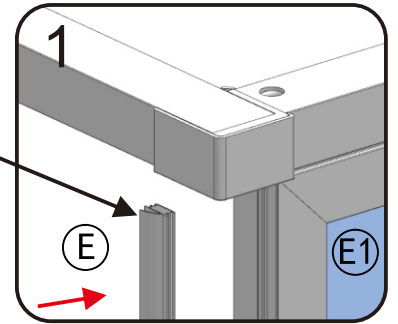
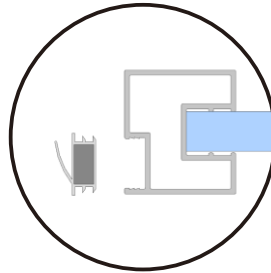
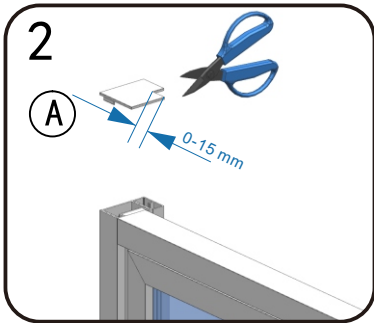
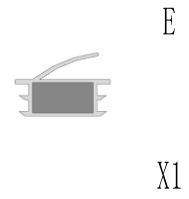
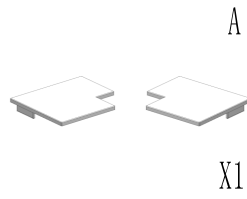

(NO) Påfør en tynn stripe med silikon på utsiden, mellom veggprofil og vegg.

(SE) Applicera en tunn silikonremsa på utsidan, mellan väggprofilen och väggen.

(PL) Nałóż cienki pasek z silikonu na zewn"trz, między profil cienny a cian.

(GB) Apply a thin strip of silicone on the outside, between wall profile and wall.

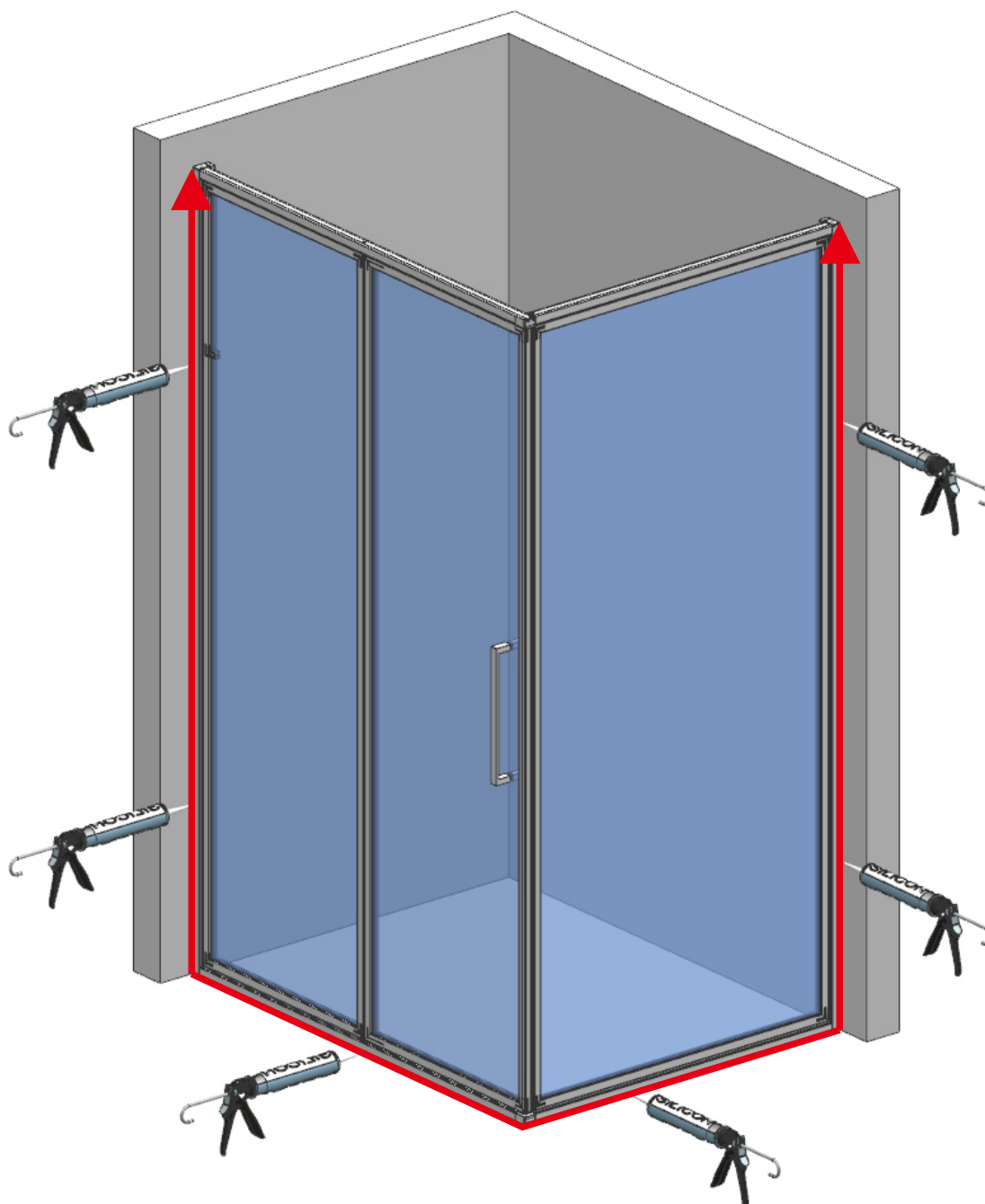

# Monteringssett tilgjengelig i butikk

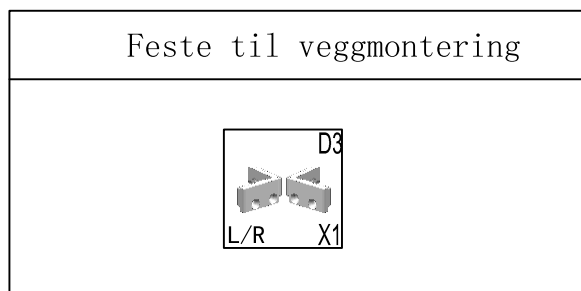

M0068

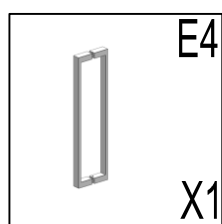

a1739

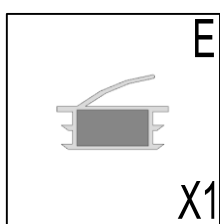

a1745

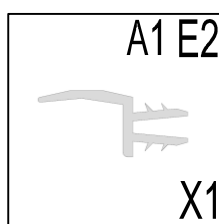

a1746

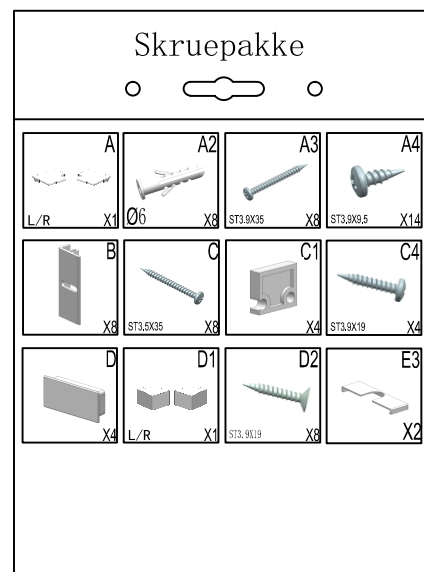

M0069

# Reservedeler tilgjengelig for bestilling

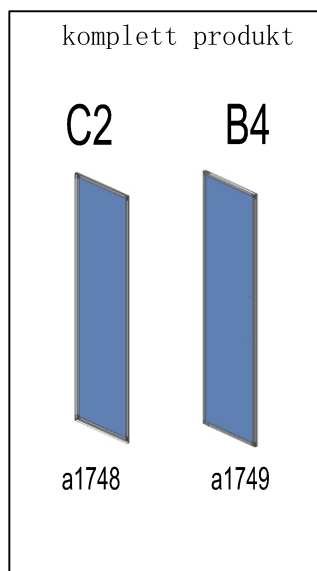

MF7501DB-120-1/2

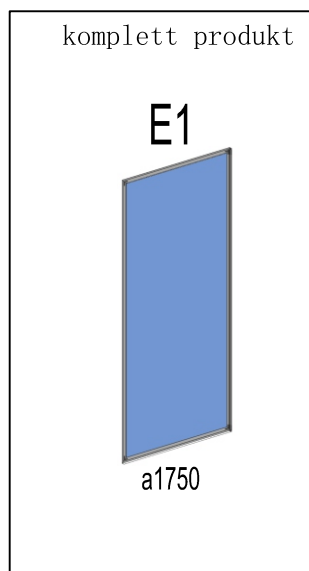

MF7501DB-120-2/2