

Uponor Aqua PLUS tap extension

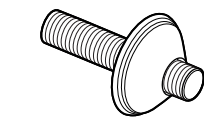

A 1/2"MT - 3/4"MT

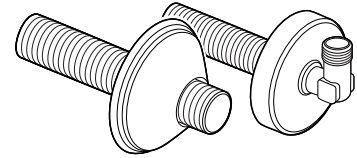
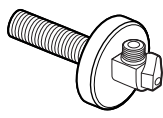

B 1/2"MT

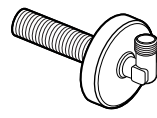

C 1/2"MT

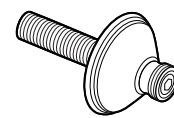

D 1/2"MT - 3/4"MT

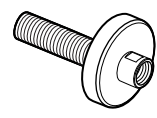

E 1/2"MT/FT

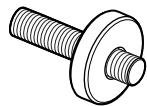

F 1/2"MT

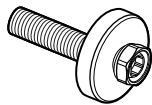

G 1/2"MT - M26SN

[mm]	A	B	C	D	E	F	G
	85	85	85	85	85	115	85
		15	15		15	15	15
		70	70		70	70	70
	25			25			
	70			70			



1

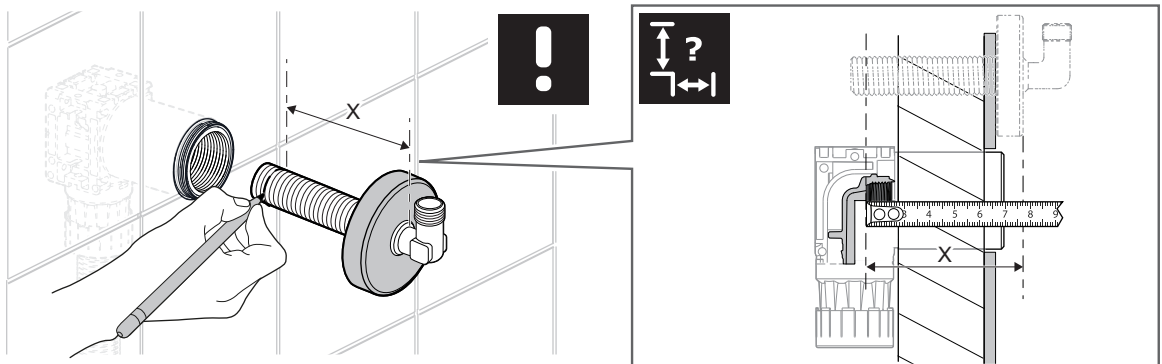

2

2.1

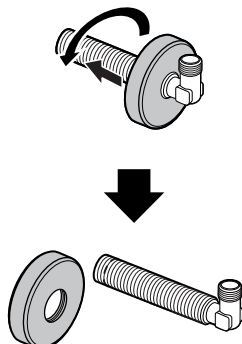

2.2

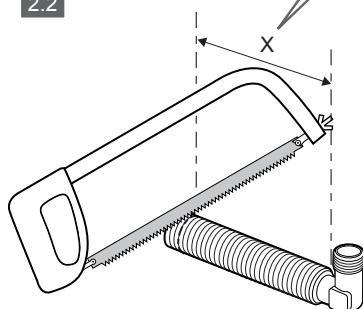

2.3

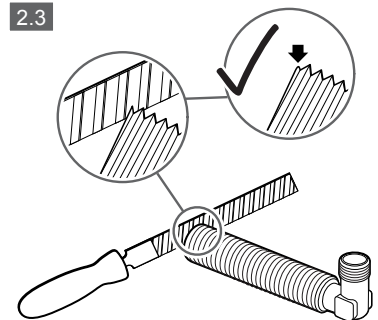

3

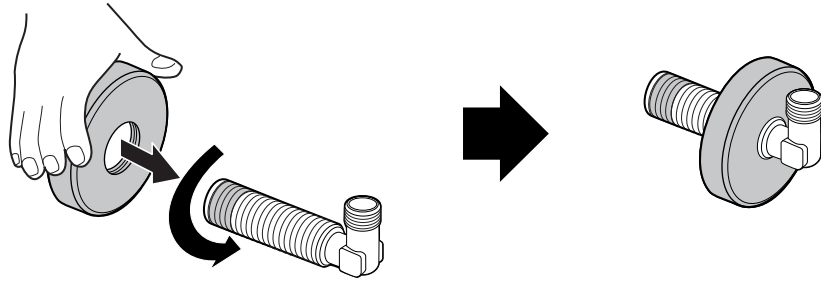

4

A PPSU 4.1

STOP 4A ~~4B~~

PTFE tapes = EN 751-3 FRp

$\frac{1}{2}''$ 0,076-0,1 mm

4.1

B Metal

4.2

OPTIONS

4A

4B

4.3

5

STOP

OK?

