

# Preloc 300-Series

Certified in accordance to EN 274-1:2002

# PREVEX

www.prevex.com

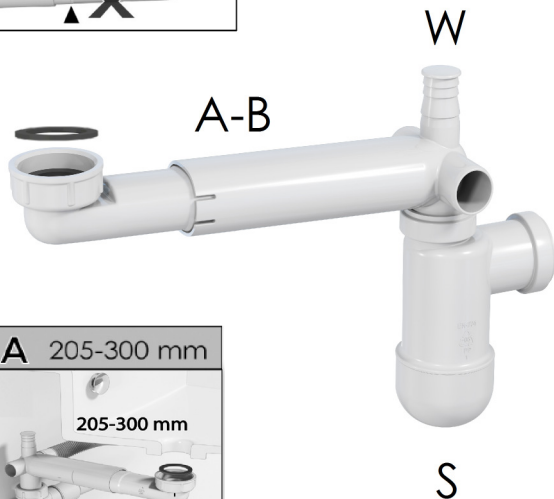
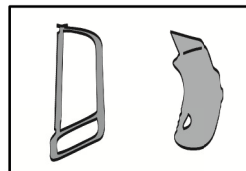
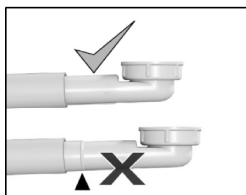

**A** 205-300 mm

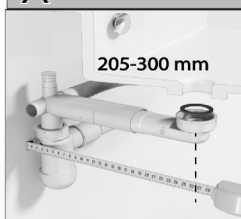

**B** LENGTH OF THE SIPHON ARM 145-205 mm

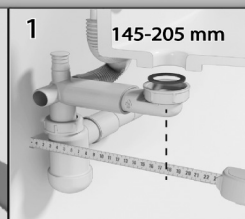
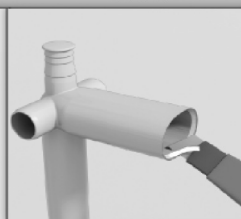

Service



s1.

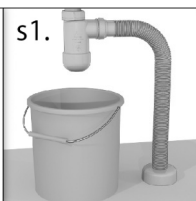

s2.

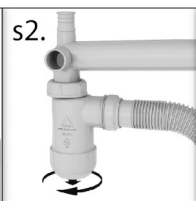

s3.

