

# FLAIR

5288801012



User manual  
Bedienungsanleitung  
Mode d'emploi  
Handleiding  
Manuale  
Manual del usuario  
Használati utasítás  
Instrukcja obsługi



# LUTEC

**Incl.**

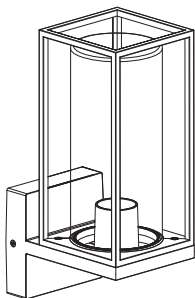

x 4



x 4

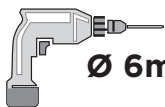

**Ø 6mm**



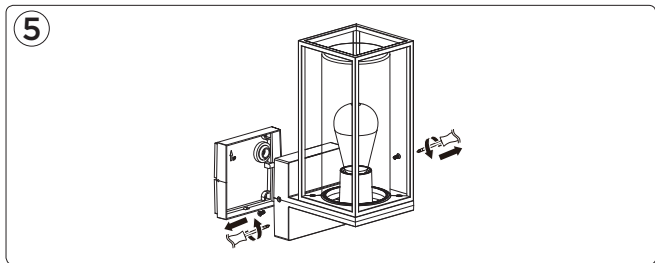
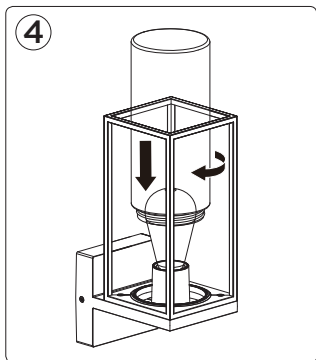
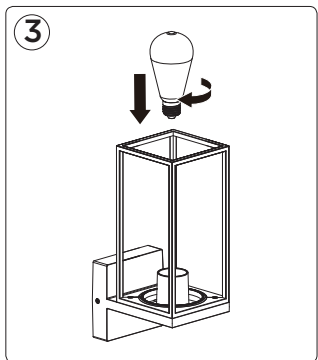
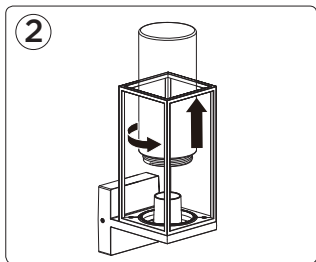
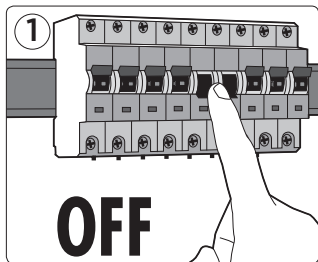

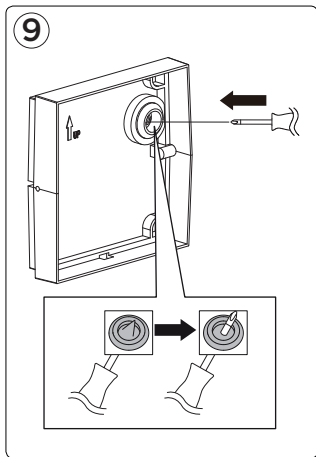
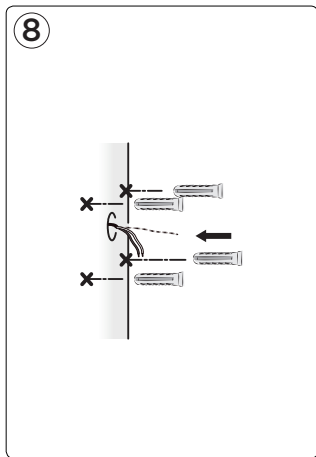
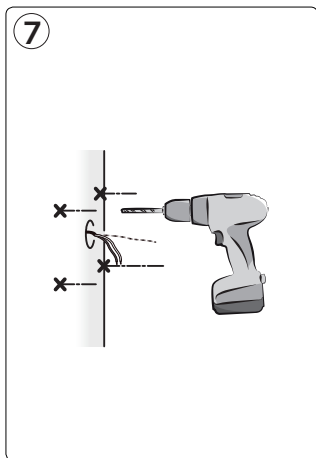
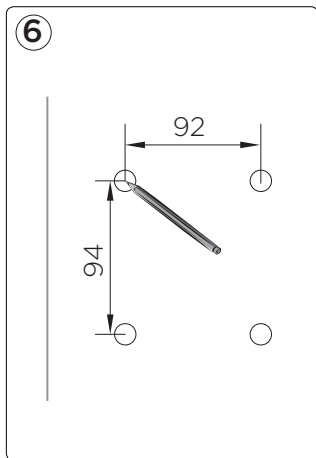

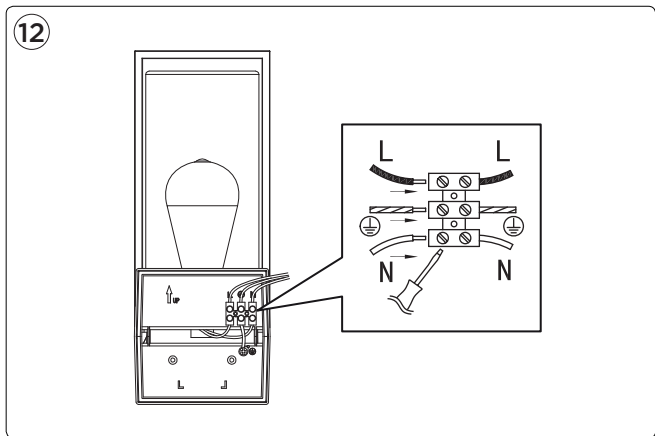
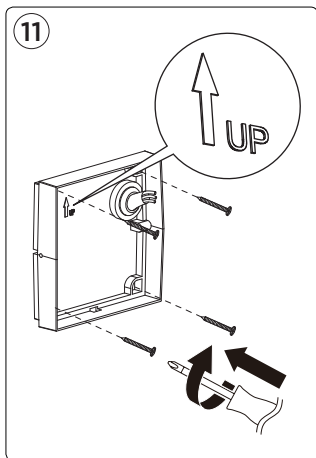
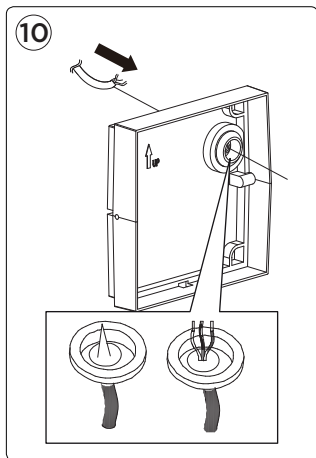

13

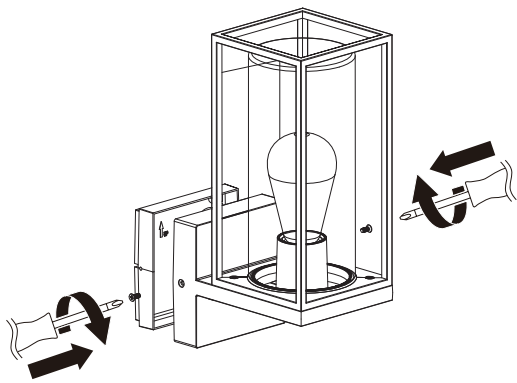



## **LUTEC Europe NV**

Herentalsebaan 425  
B-2160 Wommelgem - Belgium  
+32 3 284 51 62  
info@lutec-europe.com  
www.lutec.com



[www.lutec.com/services/global-network](http://www.lutec.com/services/global-network)