

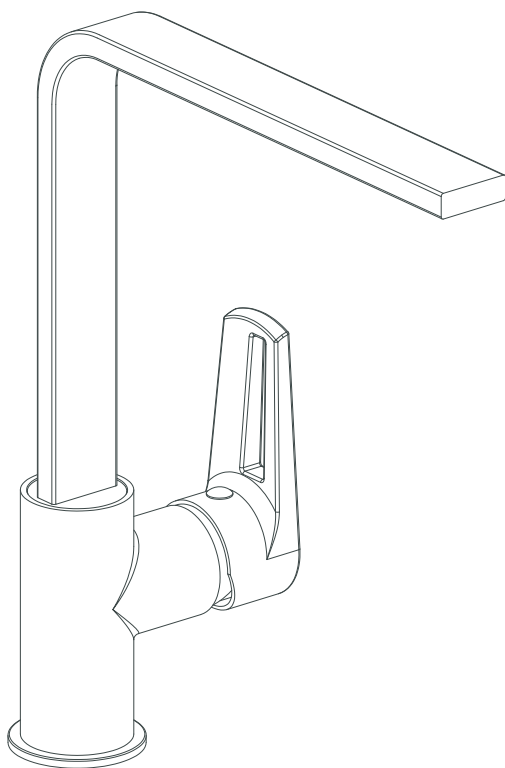





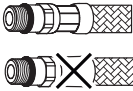

 CELESTE®

STOKE



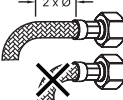

- Vennligst les disse instruksjonene nøye før du starter installasjonen og behold den for senere bruk.
- Disse instruksjonene skal beholdes av sluttbruker.
- Fjern all emballasje og kontroller produktet for manglende deler og skader før du starter installasjonen.
- Eventuelle endringer som gjøres på dette produktet og dets bruksområder vil medføre at garantien bortfaller.
- Produktet skal monteres av godkjent installatør
- Rengjør grundig gjennom alt rørarbeid før installasjon av f.eks. Dusjhoder, kraner, innløpsventiler, etc.
- Baderomsprodukter som flytende såpe, sjampo eller dusjgeler kan skade noen materialer
- Periodisk rengjøring og vedlikehold bør brukes for å unngå oppbygging av skadelige kalksteinavsetninger.

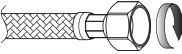
	*Før du monterer slangen, vennligst sjekk passende krymping på begge sider av slangene.
	*Verktøy skal ikke benyttes for stramming av slange.
	*Skru til for hånd til du føler motstand.
	*Fleksibel slange skal ikke monteres i vegg
NO! 	*Slangen skal strammes fast uten spenn eller vridning.
	*Langvarig kontakt med flytende stoff selv stoff uten kjemikalier, kan forårsake utvendig skade på slange.
	*Slangen skal ikke bøyes mer enn 2 ganger den ytre diameteren.
	*Slangen skal ikke monteres slik at det oppstår vinkler.
	*Mutter skal dreies for hånd og deretter 1/4 omdreining ved hjelp av en skiftenøkkel.



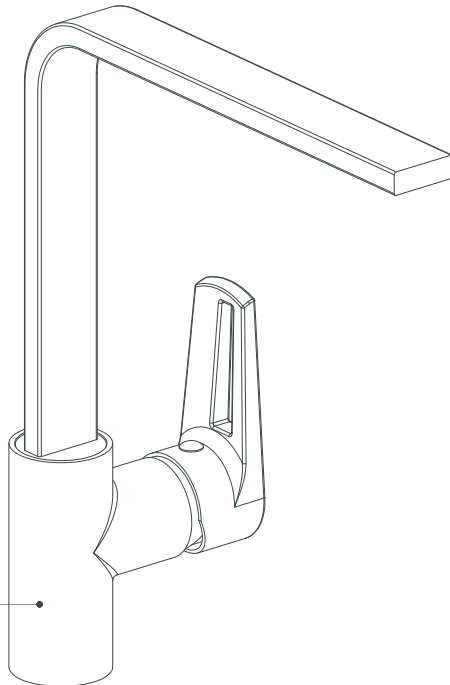
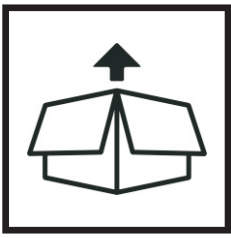

Blandehus



Avstandstykke



O-ring

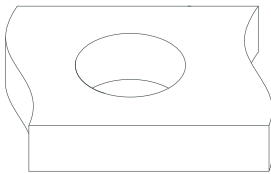

Mellomlegg



Spandeskive

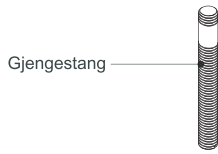

Gjengestang



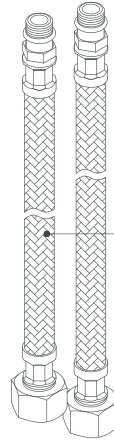

Mutter

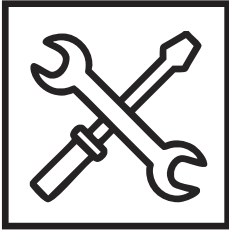

Fleksibel tilslutningslange

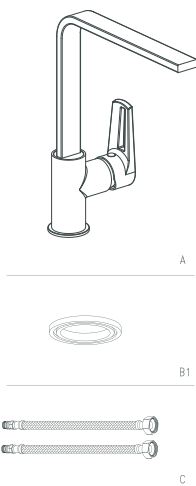
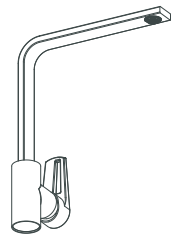
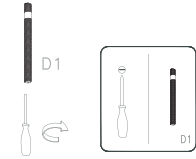
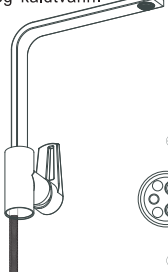
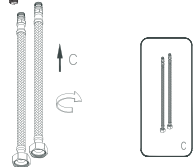
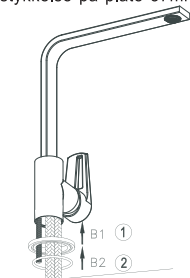

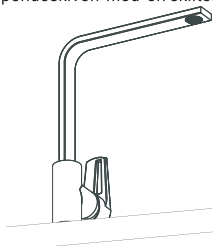
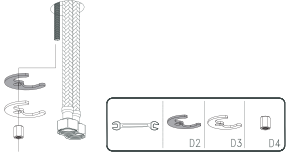
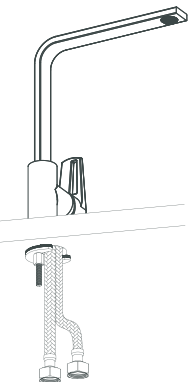
 <p>A</p> <p>B1</p> <p>C</p>	<p>1. Skru inn gjengstengene (D1) i blande-batteriet med en skrutrekker.</p>  <p>D1</p> <p>D2</p> <p>D3</p> <p>D4</p> 	<p>2. Skru fast tilslutningslangene (C) forsiktig for hånd inn der det indikeres for varmt og kaldtvann.</p>  <p>C</p> 
<p>3. Plasser avstandstykket (B1) og O-ring (B2) under batteriet og før tilslutningslangene gjennom plate, makstykkelse på plate 37mm.</p>  <p>B1</p> <p>B2</p> <p>1</p> <p>2</p> <p>3</p> 	<p>4. Plasser mellomlegg (D2) og spandeskiven (D3) i gjengstengene og skru deretter muttere (D4) fast inn mot spandeskiven med en skiftenøkkel.</p>  <p>D2</p> <p>D3</p> <p>D4</p> 	<p>5. Blande-batteriet er nå klart for tilkobling til varmt og kaldtvann.</p> 

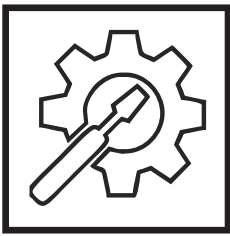

1. Steng helt av for vann inn til blandebatteri og la resterende vann i blandebatteriet renne ut.

2. Trekk ut kappen (07) og benytt en unbrakonøkkel for å skru ut unbrakoskruen(06) løft så opp grepet (01).

3. Vipp ut kappen (02)

4. Løft ut plastkappen (03) for hånd.

5. Trekk ut patronen (04) opp fra blandehuset (05) og skyll patronen under rent rennende vann før du monterer patronen tilbake.

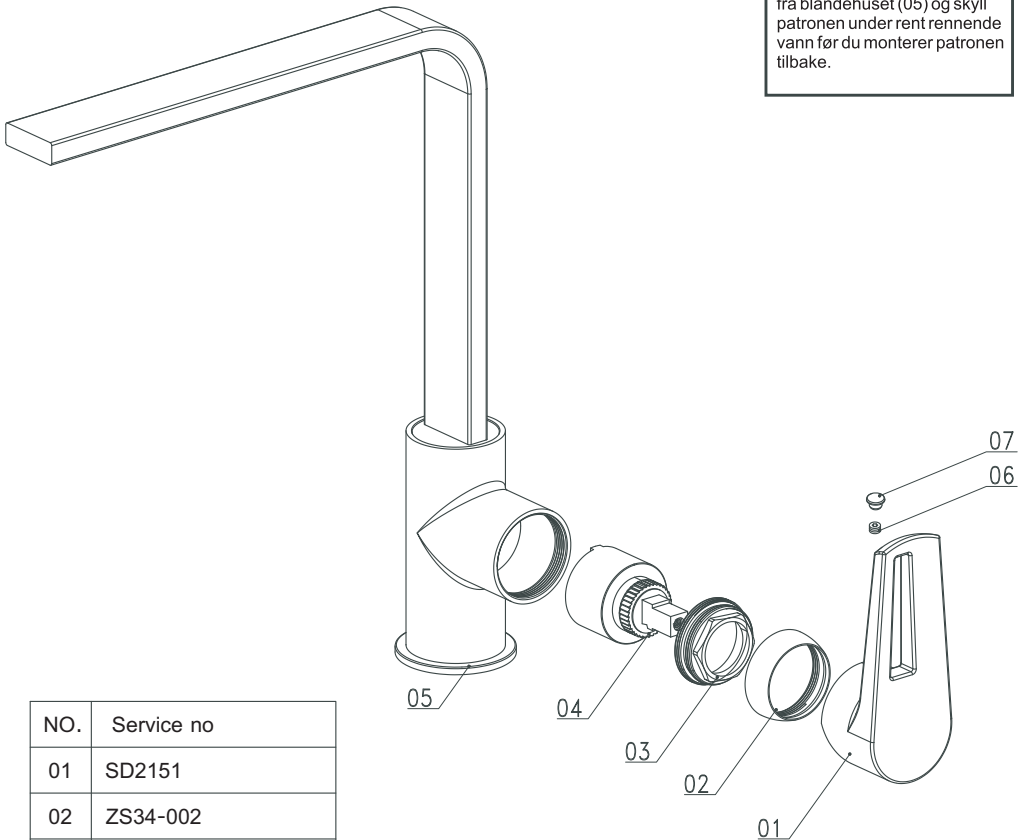

NO.	Service no
01	SD2151
02	ZS34-002
03	SD97001-0-10P
04	CT35TF001
05	SD91145-00-01
06	M5*6
07	SDBZ-003

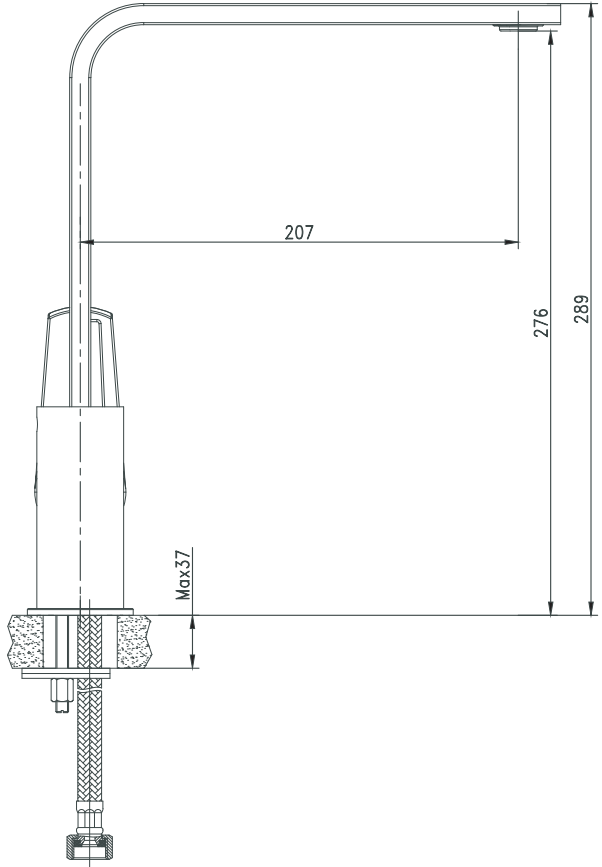
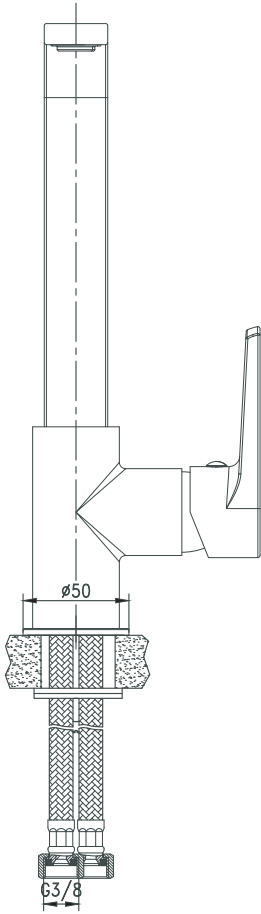
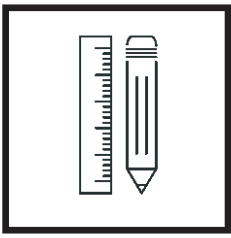

 **Produktsertifikat****Nr. 3471**

SINTEF Byggforsk bekrefter at

**Celeste ettgreps servantbatterier,
med sertifisert tilslutning**

er i samsvar med kravene i:

EN 817

NKB produktregler 4

Produktreglene er trykktestet ved 16 bar

Innehaver av sertifikatet:

MegaFlis AS

Billingstadsletta 14

1396 Billingstad