

# INSTRUCTION MANUAL

Monteringsveiledning

Monteringsguide

instrukcje składania

Instruction manual

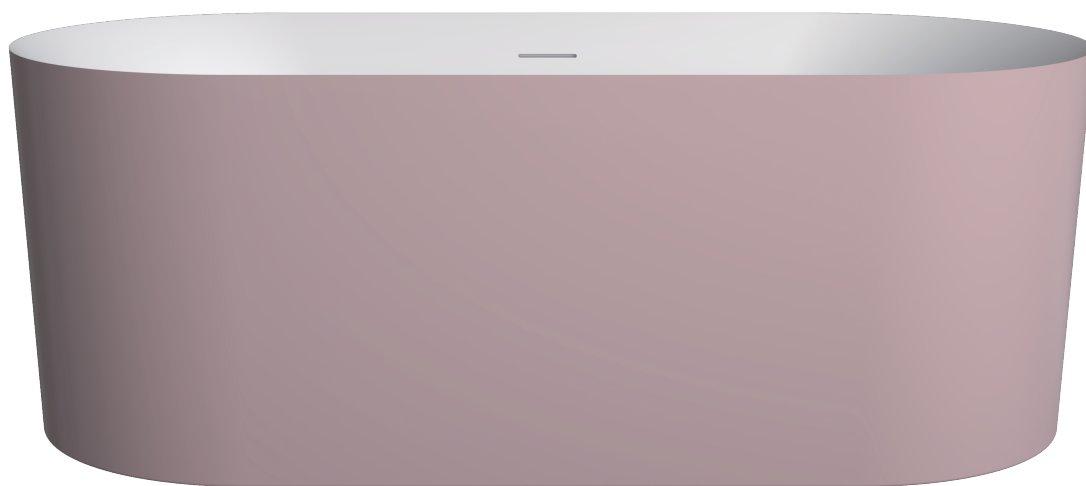

CELESTE MESSINA 166 ROSA  
BT1900PN-166F

## TOOLS AND MATERIALS REQUIRED

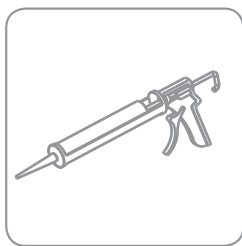
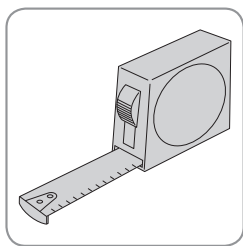
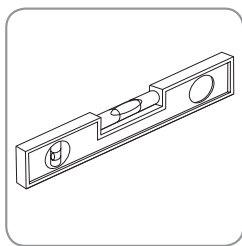
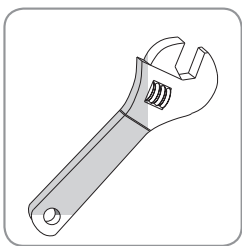

## Feet

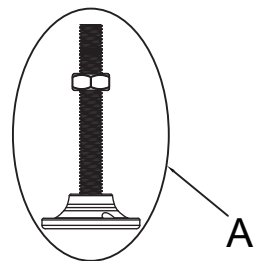
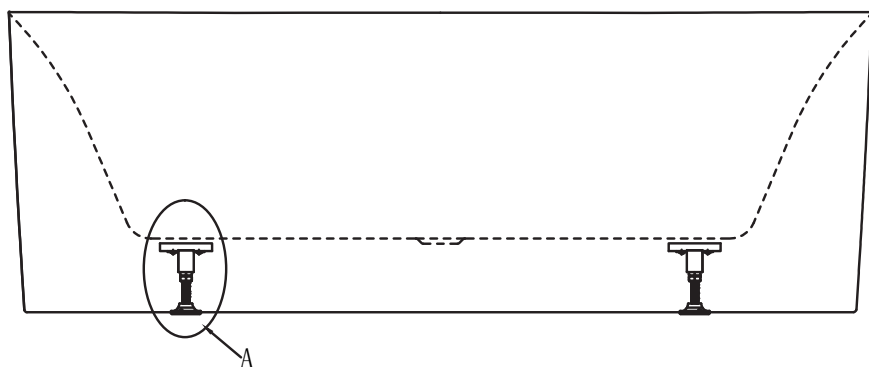

Nr.	Description	Article number
A	Bathtub Foot	TJLG.M12

## Drain

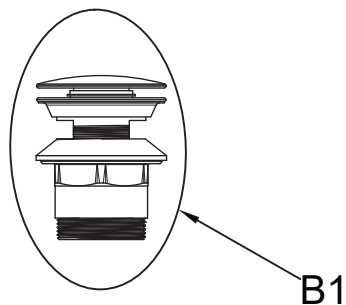
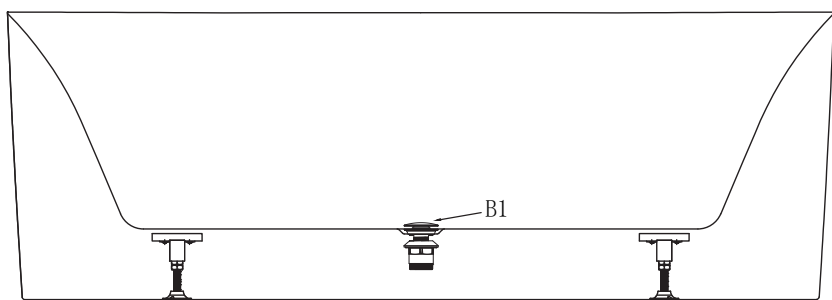

Nr.	Description	Article number
B1	Pop Up Drain	D9-1-WH
B2	Drain pipe	XBG-L

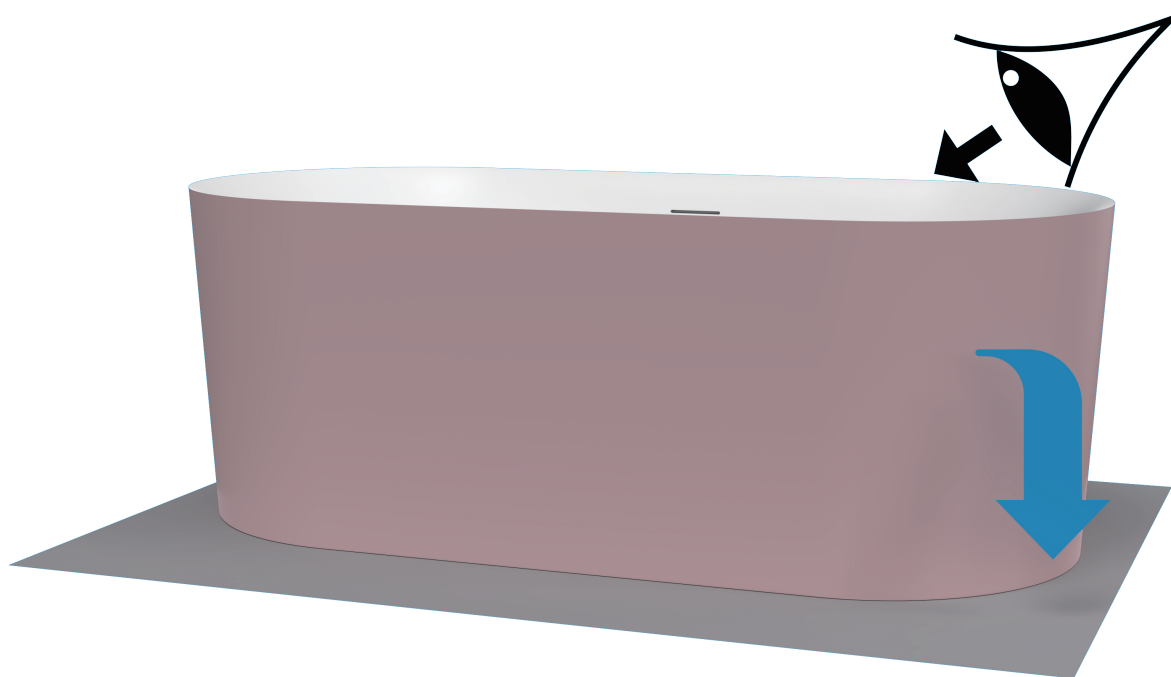

**NO** - Undersøk badekaret for skader før montering

**SE** - Inspektera badkaret för skador före installation

**PL** - Przed montażem sprawdź wannę pod kątem uszkodzeń

**GB** - Inspect the bathtub for damage before installation

# INSTALLATION

## Step 1



- NO** – Monter avløpsslangen på bunnventilen. Stram forsiktig
- SE** – Montera avloppsslangen på bottenventilen. Dra åt försiktigt
- PL** – Monteruj wąż odpływu na zawór dna. Dokręć delikatnie
- GB** – Fit the drain hose to the bathtub drain stopper. Tighten carefully



## Step 2

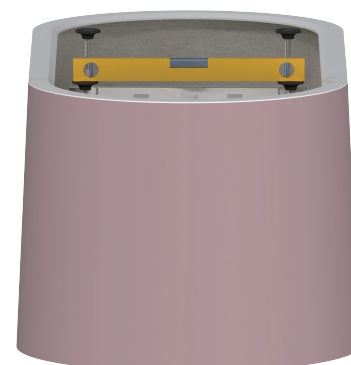
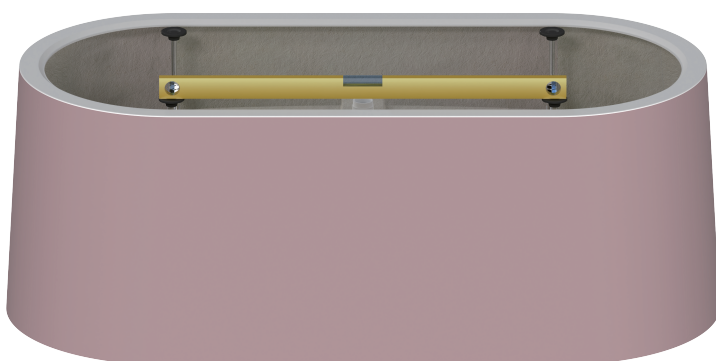

- NO** – Juster bena slik at de er i samme høyde, og ligger på linje med undersiden av badekaret
- SE** - Justera benen så att de är på samma höjd, och ligger i linje med undersidan av badkaret
- PL** - Dopusuj nogi tak, aby były na tej samej wysokości i znajdowały się w linii z dolną stroną wanny
- GB** – Adjust the legs to the same height, and make sure that they are at the same level as the underside of the bathtub



Step 3

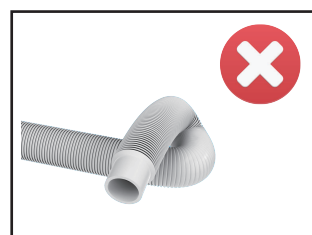
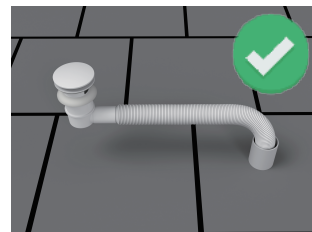

Step 4

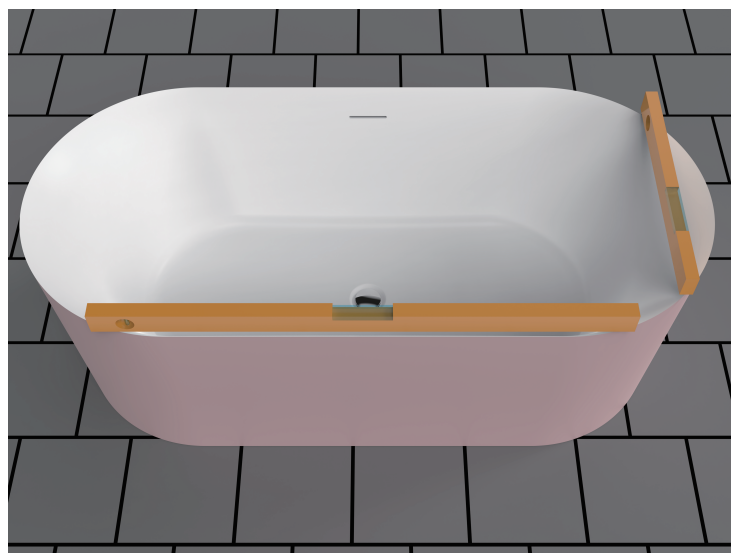

- NO** - Juster bena slik at badekaret er i vater
- SE** - Justera benen så att badkaret står stadigt på samma våglängd
- PL** - Dopusuj nogi, aby wanna była w poziomie
- GB** - Adjust the legs so that the bathtub is leveled



## Step 5

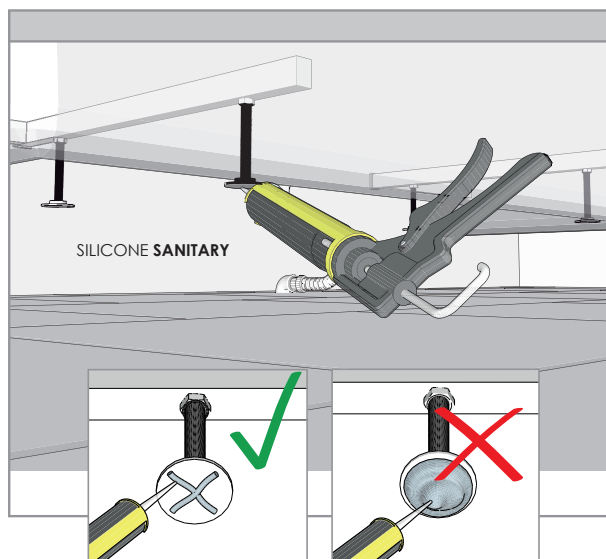

**NO** – Dersom badekaret ikke står stødig, påfør eventuelt litt silikon under bena

**SE** - Om badkaret inte står stadigt, applicera eventuellt lite silikon under benen

**PL** - Jeśli wanna nie stoi stabilnie, nałóż trochę silikonu pod nogi

**GB** – If the bathtub is not stable, apply some silicone under the feet

## Step 6

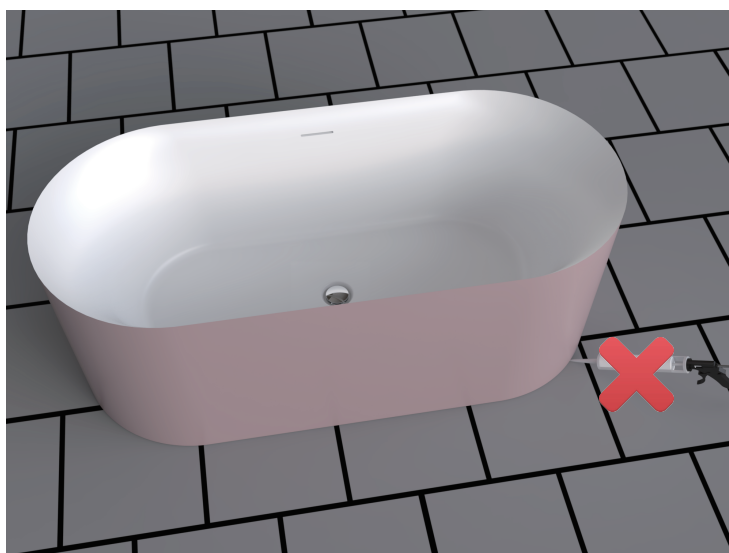

**NO** – Viktig! Ikke legg silikon mellom gulv og badekar

**SE** - Viktigt! Lägg inte silikon mellan golvet och badkaret

**PL** - Ważne! Nie nakładaj silikonu między podłogą a wanną

**GB** – Important! Do not put silicone between the floor and the bathtub

# Maintenance

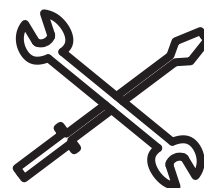

**NO** - Badekaret er laget av akryl og kan rengjøres med en fuktig klut og vann med et mildt rengjøringsmiddel. Husstandsrengjøringsmidler med aggressive, klorerte og/eller abrasive ingredienser bør ikke brukes da dette kan skade utsiden på badekaret. Kalk kan fjernes med produkter basert på sitronsyre. Bruk aldri eddiksyre ettersom dette vil skade overflaten.

**SE** - Badkaret är tillverkat av akryl och kan rengöras med en fuktig trasa och vatten med en mild rengöringsmedel. Hushållsrengöringsmedel med aggressiva, klorerade och/eller slipande ingredienser bör inte användas, eftersom det kan skada ytan på badkaret. Kalkavlagringar kan bäst tas bort med en produkt baserad på citronsyra. Använd dock aldrig ättiksyra, eftersom det kan skada akrylytan.

**PL** - Wanna wykonana jest z akrylu i można ją czyścić wilgotną ściereczką i wodą z dodatkiem delikatnego detergentu. Nie należy używać domowych środków czyszczących zawierających agresywne, chlorowane i/lub ściernie składniki, ponieważ spowoduje to uszkodzenie powierzchni wanny. Osady wapienne najlepiej usunąć preparatem na bazie kwasu cytrynowego. Nigdy jednak nie używaj kwasu octowego, ponieważ spowoduje to uszkodzenie powierzchni akrylowej.

**GB** - The bathtub is made of acryl and can be cleaned with a damp cloth and water with a mild detergent. Household detergents with aggressive, chlorinated and/or abrasive constituents may not be used because this will damage the surface of the bathtub. Limescale can best be removed with a product based on citric acid. However, never use acetic acid, the acryl surface material will be irreversible damaged.