

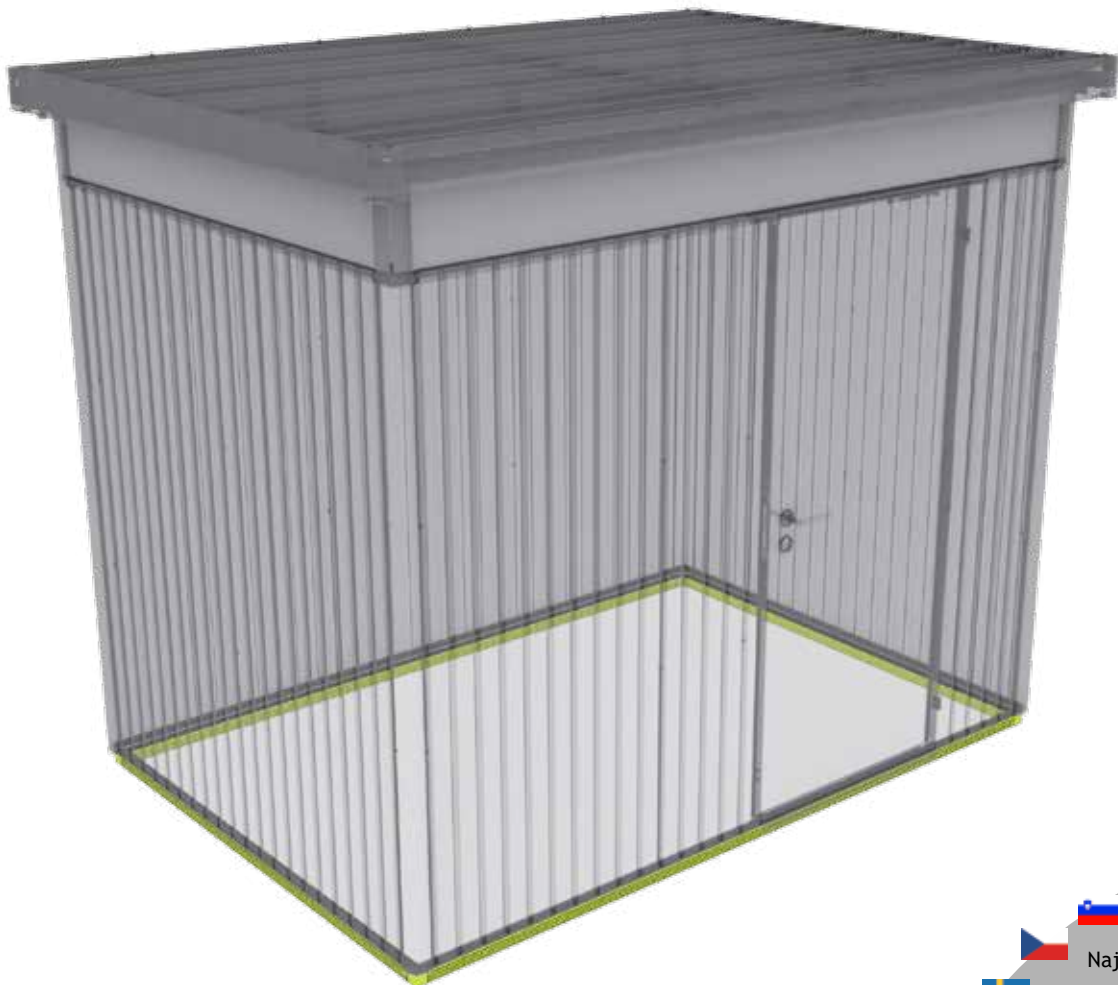

Aufbauanleitung „Bodenrahmen“

DE

(sinngemäß für alle Größen der Gerätehäuser „HighLine“, „AvantGarde“, „Panorama“ und „Europa“, sowie für den „Geräteschrank“ und die „MiniGarage“)

- Ⓞ GB Assembly manual "Floor Frame"
- Ⓞ FR Notice de montage "Cadre de sol"
- Ⓞ NL Opbouwbeschrijving "Bodemframe"
- Ⓞ ES Instrucciones de montaje "Telaio perimetrale"
- Ⓞ IT Istruzioni di montaggio "Marco de suelo"
- Ⓞ DK Monteringsvejledning "Bundramme"



 Poišćite vař prevod na ...

 Najděte svůj překlad ...

 Hitta din översättning ...

 Finn din oversettelse ...

 Találja meg fordítását ...



Wichtige Punkte für den Aufbau!

Vorliegende Aufbauanleitung zeigt den Zusammenbau des „Alu-Bodenrahmens“ für das Gerätehaus „HighLine“. Sie gilt sinngemäß auch für die Gerätehäuser „AvantGarde“, „Europa“, „Panorama“, sowie für den „Geräteschrank“ und die „MiniGarage“.

- (GB)** *Important details regarding assembly! This assembly manual shows the erecting of the "Alu Floor Frame" for the garden shed "HighLine". It is also valid for the garden sheds "AvantGarde", "Europa", "Panorama" as well as for the "Equipment Locker" and the "MiniGarage".*
- (FR)** *Points importants lors du montage! Cette notice montre l'assemblage du « cadre de sol en aluminium » pour l'abri de jardin « HighLine ». Elle s'applique aussi aux abris de jardin « AvantGarde », « Europa », « Panorama », à « l'armoire à outils » et au « MiniGarage ».*
- (NL)** *Belangrijke punten voor de montage! Deze opbouwbeschrijving toont de montage van de "ALU-bodemplaat" voor de berging "HighLine". Die geldt ook voor de bergingen "AvantGarde", "Europa", "Panorama" en voor de "Tuinkast" en "MiniGarage".*
- (ES)** *Notas importantes para el montaje: En las instrucciones se muestra el montaje del marco de suelo de aluminio para las casetas "HighLine". Son válidas también para las casetas "AvantGarde", "Europa" y "Panorama", así como para el "armario de jardín" y el "MiniGarage".*
- (IT)** *Indicazioni importanti per il montaggio! Le istruzioni di montaggio fanno vedere l'assemblaggio del "Telaio perimetrale in alluminio" per la casetta portattrezzi "HighLine". Queste istruzioni di montaggio valgono in modo analogo per le cassette portattrezzi "AvantGarde", "Europa", "Panorama", e anche per l'"Armadio per attrezzi" e per la "MiniGarage".*
- (DK)** *Vigtig information til montage! Denne vejledning viser montage af "Alu-gulvramme," for "HighLine" Redskabsrumet. Vejledningerne er også gældende for øvrige modeller redskabsrum "AvantGarde", "Europa", "Panorama", samt for "Redskabsrum" og "MiniGarage".*



Wasserwaagen - Symbol:

Betreffendes Einbauteil mit der Wasserwaage ausrichten.

- (GB)** *Symbol of spirit level: Align the respective parts by using the spirit level.*
- (FR)** *Symbole niveau à bulle: Lorsque ce symbole apparaît, vous devez ajuster l'élément à l'aide d'un niveau à bulle.*
- (NL)** *Waterpas - symbol: Bij montageschappen waar dit symbool bijstaat is het noodzakelijk het betreffende onderdeel waterpas in te bouwen.*
- (ES)** *Símbolo del nivelador: Indica que se debe ajustar y centrar la pieza con la ayuda de un nivelador.*
- (IT)** *Simbolo di livella a bolla d'aria: Allineare il componente in questione con l'ausilio di una livella a bolla d'aria.*
- (DK)** *Symbol for vaterpas: Juster de respektive dele ved hjælp af vaterpas.*

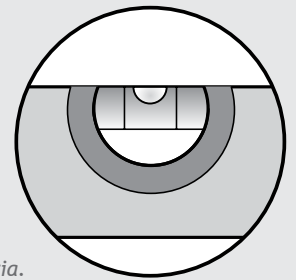

Verwenden Sie bei der Montage Arbeitshandschuhe!

- (GB)** *Wear working gloves!*
- (ES)** *Utilice unos guantes de trabajo.*
- (FR)** *Portez des gants de travail!*
- (IT)** *Utilizzare guanti da lavoro!*
- (NL)** *Handschoenen gebruiken!*
- (DK)** *Brug arbejdshandsker!*



Paket

Bodenrahmenpaket · Package for floor frame · Colis du cadre de sol · Bodemframepakket · Paquete del marco de suelo · Pacchetto telaio perimetrale · Gulvrammepakke

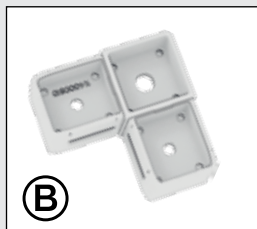



HighLine® / Panorama

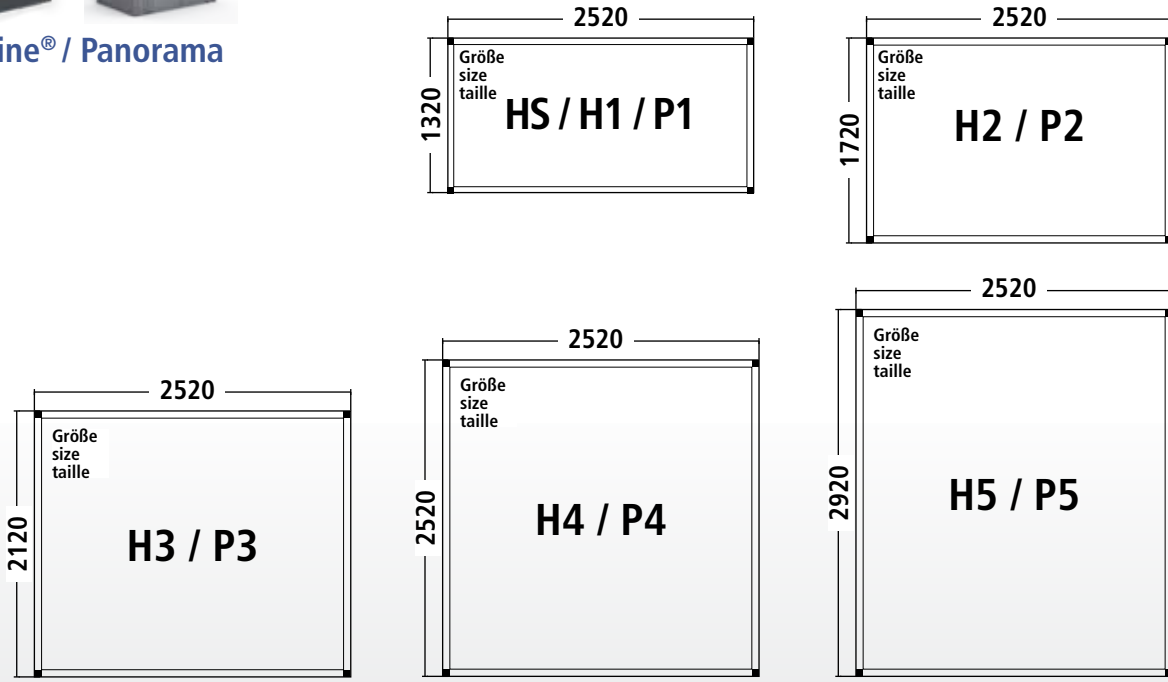

AvantGarde®

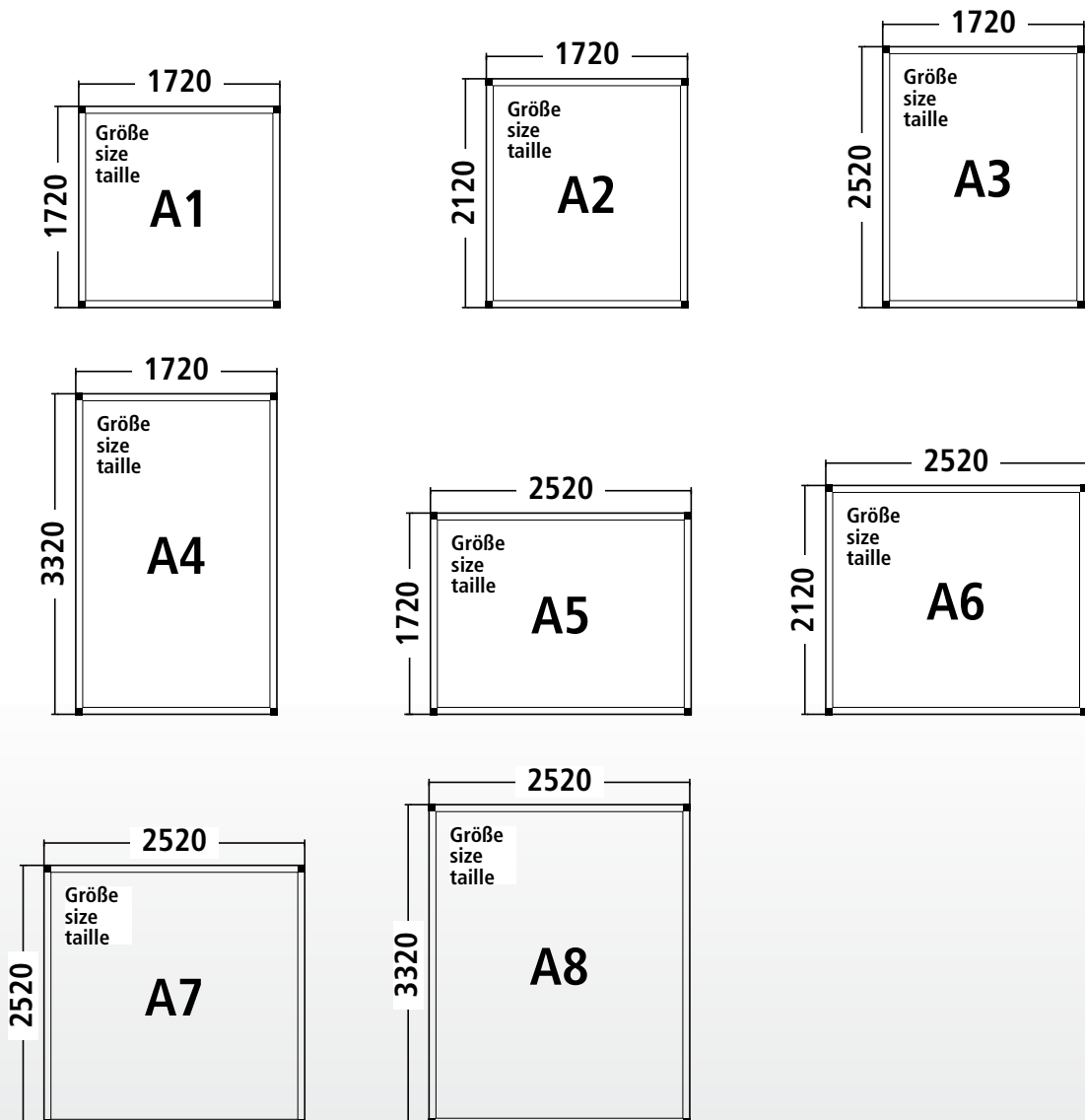



Europa

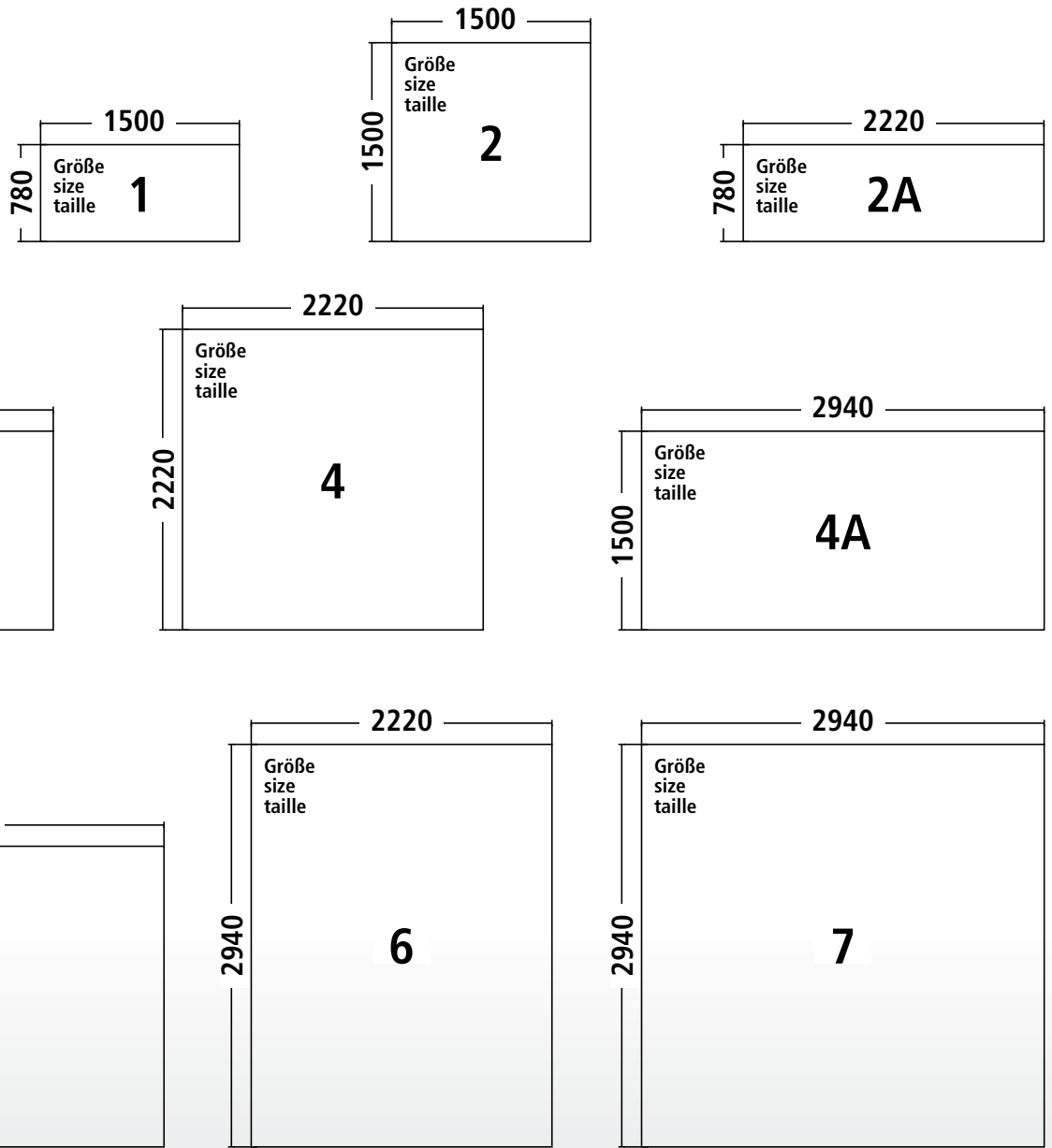

Geräteschrank

Equipment locker
Armoire à outils

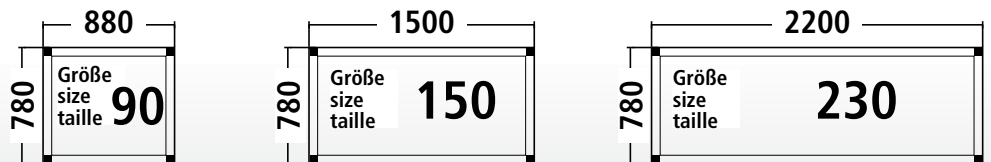

MiniGarage

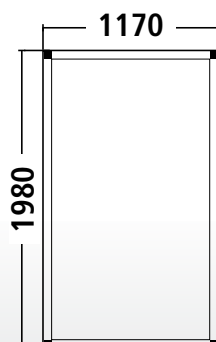

1.

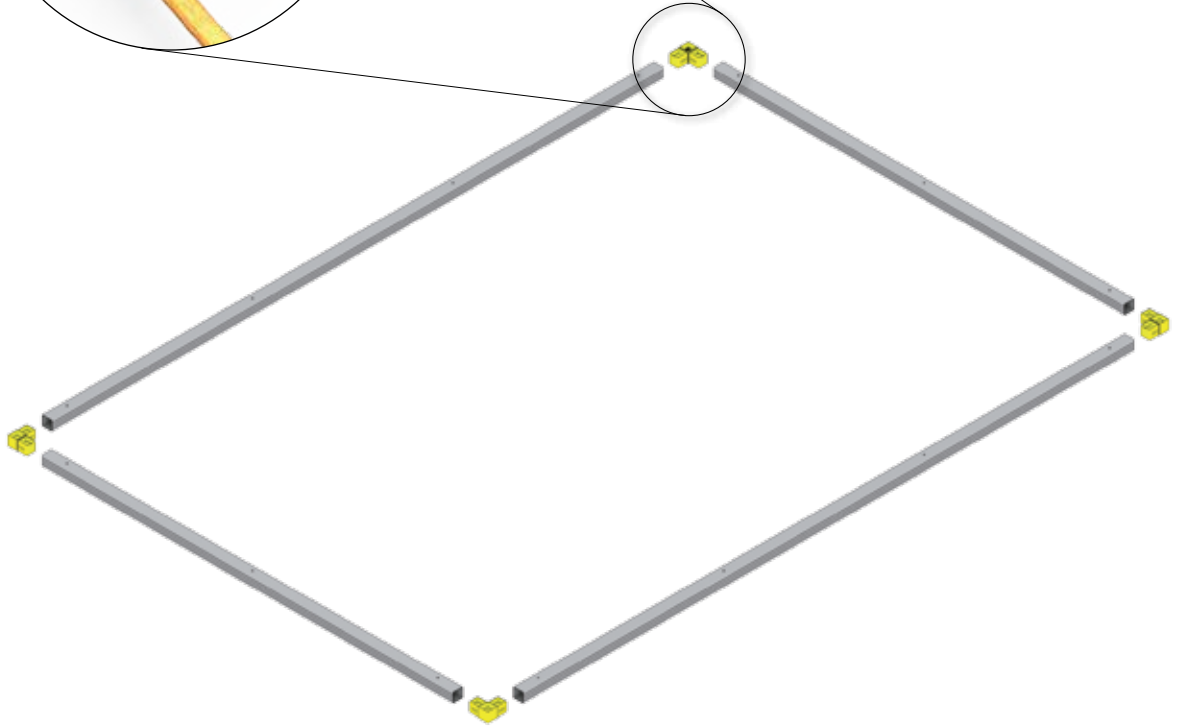
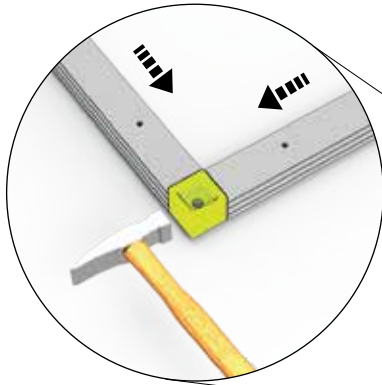
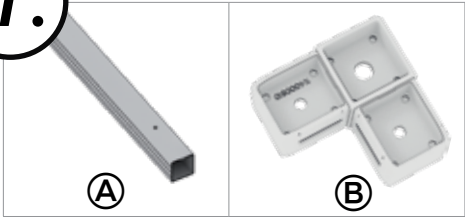

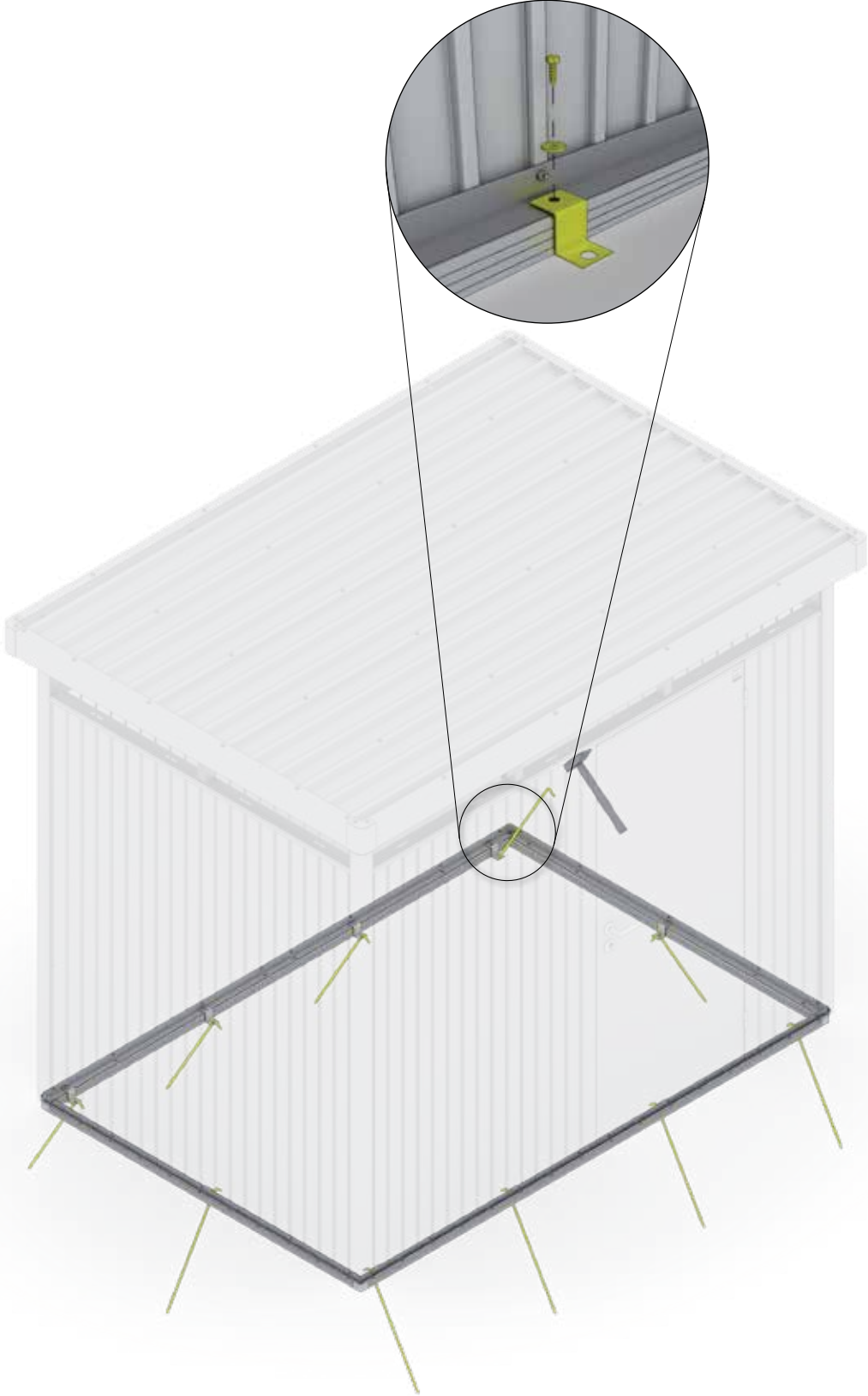
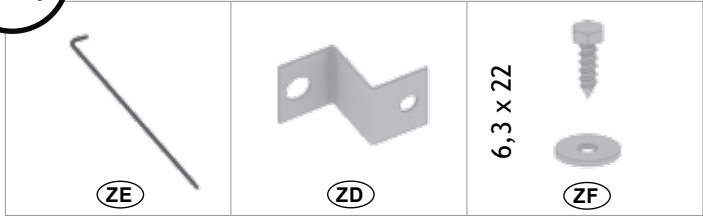

2.

Variante 1 - Proposal 1 - Variant 1



2.

Variante 2 - Proposal 2 - Variant 2

8 x 60			6,3 x 22	
	(D1)			(ZF)

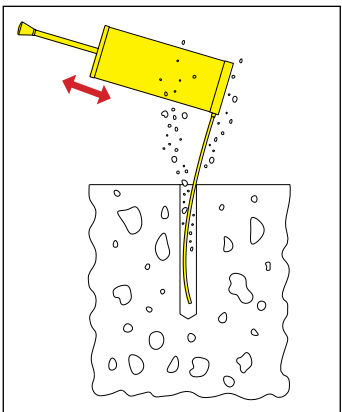
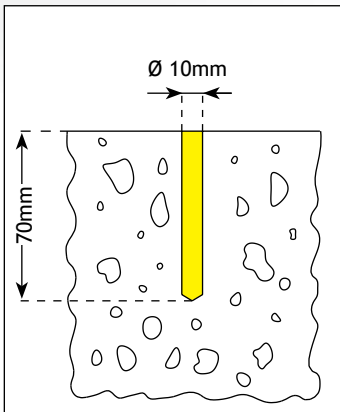
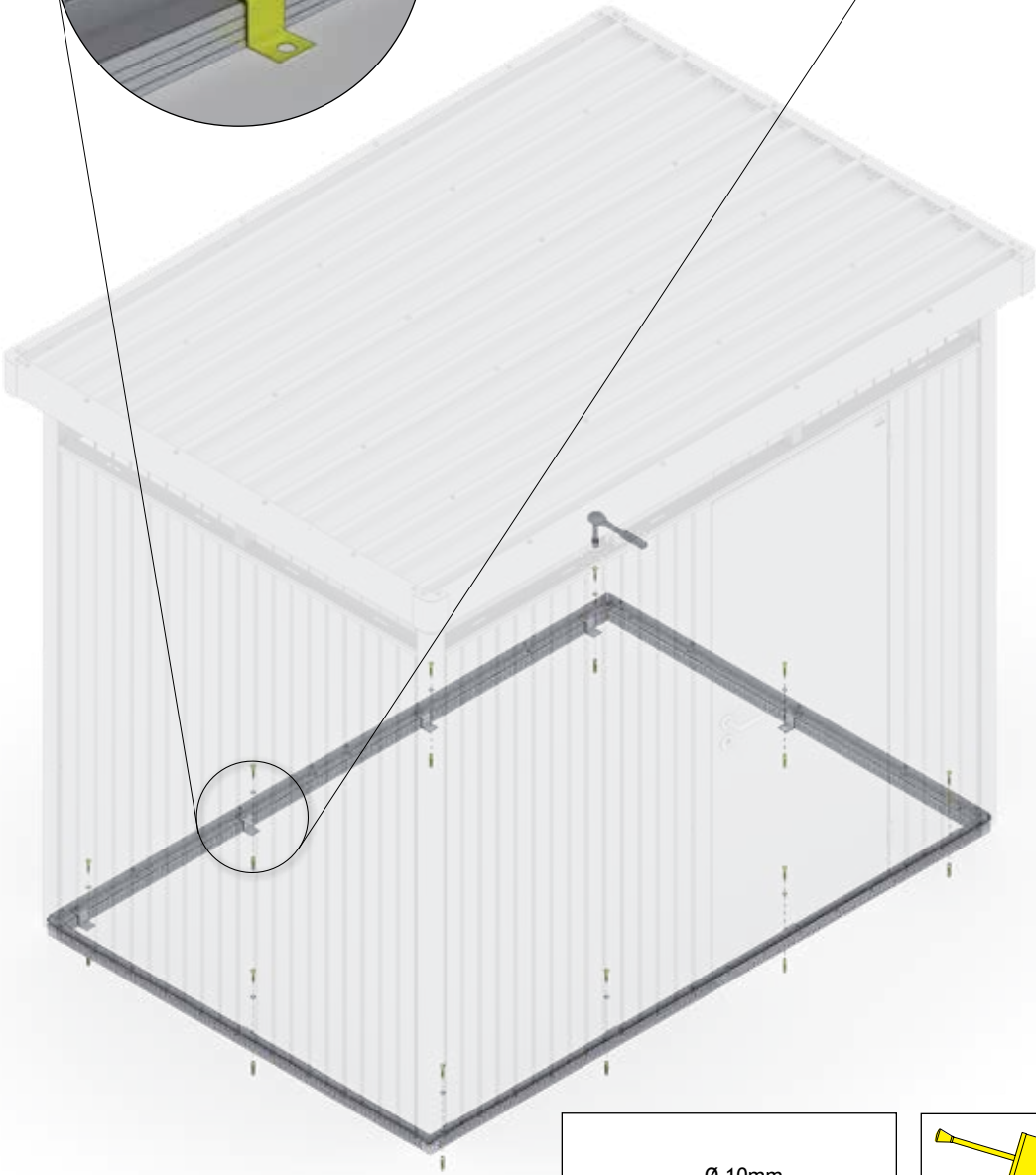
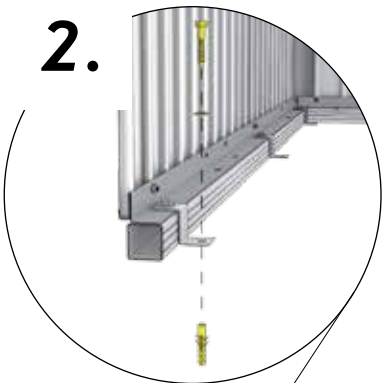
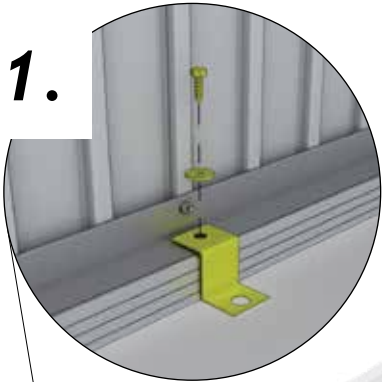



Gerätehäuser

Setzen Sie auf
Qualität & Langlebigkeit



Gartenboxen

Outdoorboxen für
Garten, Terrasse & Co



Fahrrad-Garagen

Fahrräder, Roller & Co sicher
verstaut



Mülltonnen-Boxen

Stylisch, praktisch
und wartungsfrei



Brennholzlager

Kaminholzlager und Geräte-
schrank in einem



Pflanzgefäße und Garten-Helfer

Gartendesign
in Bestform

Kontrollnummer:
Control-number / Contrôle-Qualité / Controlnummer:



Bei Reklamationen bitte anführen:
Kontrollnummer und Artikelnummer des reklamierten Teils.

GB: In case of complaint please indicate the control-number and the number of the item, which is subject of complaint.

F: Pour toutes réclamations: prière de joindre le numéro de contrôle et le numéro d'article de la pièce litigieuse.

NL: Bij reclamaties svp doorgeven: controlnummer en artikelnummer van het desbetreffende onderdeel.