

MORE FROM WOOD.



Installation instructions
for Egger Laminate
Flooring with CLIC it!
installation system



CLIC it!



1. Required Inspection Prior to Installation

EGGER Laminate Flooring is made following very precise operation steps in state-of-the-art production plants. Stringent quality inspections are carried out regularly both during and at the end of the manufacturing process. There may be occasions however, when damage to individual boards occurs, for example during transport, despite the quality checks. Accordingly, the flooring boards must be inspected for possible defects prior to and during installation. Damaged flooring boards or those that differ from the norm should not be installed but returned to the supplier to be replaced.

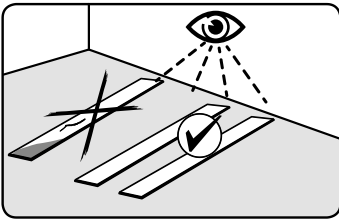

2. Subfloor

2.1

As a general rule:

- The subfloor prepared for installation must be dry, clean, free of separating agents, crack-free, level, as well as display tensile and compression strength in accordance with DIN 18365 and DIN 18202.
- With regard to evenness, the raised requirement of $\leq 2 \text{ mm/m}$ must be observed.
- The flooring contractor must, within the scope of the inspection and due diligence requirement, make sure prior to installing the flooring that the subfloor has the required installation suitability and must report “concerns” in writing if the subfloor is not suitable for installation, i.e. if there are defects and / or there is a risk of damage to the top floor due to its construction.

When assessing installation suitability for EGGER’s Laminate Flooring, attention should be paid, in particular, to the points below. In the case of failure to comply, all guarantee and warranty claims will become void.

Inspections of the moisture level of the subfloor

The inspections of the subfloor moisture must be carried out to determine whether the subfloor is sufficiently dry.

Installation suitability is determined by measuring the water content in CM %. When carrying out inspections with the CM device (CM method), the following limit values must not be exceeded:

	Cement screed	Calcium sulphate screed
without floor heating	$\leq 2.0 \text{ CM } \%$	$\leq 0.5 \text{ CM } \%$
with floor heating (heated screed)	$\leq 1.8 \text{ CM } \%$	$\leq 0.3 \text{ CM } \%$

These values apply to screeds without additives. With the use of additives and in case of fast-drying screed, the measurements and limits specified by the respective manufacturer shall apply.

In some countries / regions, installation suitability is determined by measuring the corresponding relative humidity, as described below.

- KRL measurement: Limit value $\leq 75\% \text{ rH}$ for unheated screed $\leq 65\% \text{ rH}$ for heated screed
- BS 5325: Limit value $\leq 75\% \text{ rH}$ (surface measurement, United Kingdom)
- NT Built 439: Limit value $\leq 85\% \text{ rH}$ (Scandinavia)
- ASTM F2170: Limit value $\leq 80\% \text{ rH}$ (SITU sample, North America)

Required Inspection Prior to Installation / subfloor / room climate

Inspections of the evenness of the subfloor

The inspections of the evenness are based on common standards and are conducted by placing a yardstick / straight-edge on the high points of the surface and determining the gauge at the deepest location in relation to the bearing surfaces (measuring point intervals). A vertical deviation of max. 2 mm is allowed at 100 cm measuring point intervals. Larger deviations should be levelled by suitable measures (e.g. with self-levelling compounds).

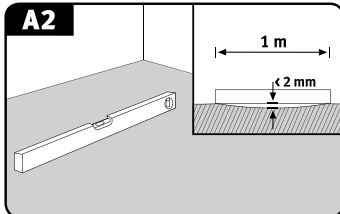

Inspections of the strength / load-bearing capacity of the subfloor

The subfloor must be a sealed, self-supporting layer.

Inspections of the cleanliness of the subfloor

The subfloor must be kept clean and be in a vacuum-cleaned condition – at all times.

Inspections of the atmospheric conditions

The following conditions should be met prior to, during and after installation:

- an air temperature of at least 18°C
- a floor surface temperature of at least 15°C
- a relative air humidity of between 40 % and 70 %.

2.2

Suitable subfloors

All subfloors are considered suitable for the floating installation of EGGER Laminate Flooring if they are suitable for installation in accordance with the above-mentioned requirements. In particular, these include:

- all types of screed including hot water-heated screed
- OSB and chipboard structures
- fibreboards
- existing floor coverings such as PVC, linoleum, natural stone slabs and ceramic tiles.

Screeds with hot water floor heating (heated screeds)

When preparing a heated flooring structure, all those involved (builder, architect, specialist heating planner, heating engineer, installer, floor covering manufacturer) must work together in a coordinated manner. All surface-heated flooring requires appropriate planning and coordination of the heating system and screed in order to ensure maximum long-term performance without causing any damage. Alongside the usual inspections on the installation subfloor, the underfloor heating / cooling function must be inspected (functional heating / cooling). This evidence of the screed construction being properly heated up and cooled down must be provided each season and be documented by means of a heating and cooling protocol.

When heating the load and heat distribution layer, a distinction is made between functional heating and floor curing heating.

- Functional heating is the proof of the heating installer that a proper structure has been built and is used to review the functionality of heated flooring structures.
- Floor curing heating is the expelling of the residual moisture in the screed until installation suitability is reached.

Subfloors / underlay materials

Attention!

- Functional heating does not guarantee that the screed has reached the residual moisture required for installation suitability. Accordingly, floor curing heating is necessary as a rule.
- EGGER Laminate Flooring is generally installed “floating”. When installing floating on heated screed, attention should be paid to the heat conductivity values of the laminate flooring and the insulating underlay. The total of the heat conductivity values for all components must be $\leq 0.15 \text{ m}^2\text{K/W}$. When using insulating underlays that are not from the EGGER range of accessories, any guarantee is rejected with regards to compliance with the effective maximum permitted heat conductivity of the overall structure for a floating installation on heated screeds.
- The surface temperature of the heated flooring structure must not exceed 28°C and heating up too quickly must be avoided.
- Installation on surface heating systems with night storage function is not permitted.

Subfloors with a limited degree of suitability

Electric surface / foil heating systems and elastic old floor coverings (PVC, cushion vinyl and linoleum) are considered to be subfloors with a limited degree of suitability.

EGGER Laminate Flooring may only be laid on electric surface / foil heating systems that:

- are equipped with temperature sensors and controllers
- have been designed relatively recently (from 2005) and have technical approval from the heating manufacturer for Laminate Flooring
- laid over the entire area without interruption – partial installation (e.g. only in walking area of the bed room) is not permitted to avoid thermal gradient inside the floor covering on the one hand and, on the other, to ensure even heat distribution.
- are not night storage heaters.

The installation of EGGER Laminate Flooring on existing floor coverings made of PVC, cushion vinyl and linoleum is only permitted if these are fully and firmly bonded, if there are no detachments and / or cracks and if no surface heating is present.

Unsuitable subfloors

EGGER Laminate Flooring may never be installed on textile floor coverings. Textile floor coverings and carpets are unsuitable as subfloors for reasons of strength and hygiene and must be removed. In the case of failure to comply, all guarantee and warranty claims will become void.

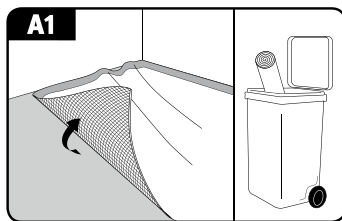

Mineral subfloors

For floating installation of Laminate Flooring on mineral subfloors (screeds, heated screeds, tiles, etc.), a moisture protection film with SD value $\geq 75 \text{ m}$ must always be installed as a vapour barrier over the entire surface and in a trough shape. When professionally installed, the moisture protection film must overlap by 5 - 20 cm in the joining areas depending on the design. In order to improve the impact noise insulation, a system-specific insulation underlay to be placed on top is recommended. When using EGGER Silenzio Duo, EGGER Silenzio Easy SD or a comparable 2-in-1 insulation underlay with integrated moisture protection, no separate moisture protection film is required.

Floor structure:

1. Mineral subfloor
2. Underlay materials (moisture protection film (vapour barrier) and impact noise insulation underlay)
Option A: EGGER Silenzio Duo or Silenzio Easy SD
Option B: EGGER Aqua+ Aluflex and EGGER Silenzio Easy or EGGER Aqua+ Aluflex and EGGER Silenzio Cork
3. EGGER Laminate flooring

Subfloors / underlay materials / wet and damp areas, locations and / or conditions

Attention!

For EGGER Laminate Flooring with Silenzio underlay laminated on the back, no further impact noise insulation underlay may be installed.

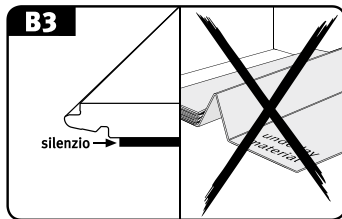

Subfloors made of wood (OSB, chipboard and fibreboard, real wood floor boards)

Any loose floor boards or other types of boards should be properly screwed down. The Laminate Flooring boards are to be installed at right angles to the longitudinal direction of the wooden floor boards.

To improve the impact noise insulation, a system-specific insulation underlay should be installed under Laminate Flooring. EGGER Laminate Flooring with Silenzio underlay mat laminated on the back are laid directly on top of the wood-based flooring boards or wooden floor boards.

Floor structure:

1. Wood-based subfloor
2. Impact noise insulation underlay, such as EGGER Silenzio Easy or EGGER Silenzio Cork
3. EGGER Laminate flooring

Underlay materials

- On mineral subfloors, a moisture protection film, SD value ≥ 75 m, must be installed over the whole area in a trough shape. An exception is the use of EGGER Silenzio Duo, EGGER Silenzio Easy SD or a comparable 2-in-1 insulation underlay with integrated moisture protection. In this case, a separate moisture protection film is not necessary.
- Do not place moisture protection film on wooden subfloors.
- A system-specific EGGER Silenzio underlay mat must be used under EGGER Laminate Flooring. Alternative underlay mats are available at www.egger.com.
- The exception to this is when using EGGER Laminate Flooring with a Silenzio underlay mat laminated to the back. No other impact noise insulation underlay must be used in this case.

Wet / damp areas, locations and / or conditions

EGGER Laminate Flooring is not suitable for installation in wet and damp areas, locations and / or conditions, such as bathrooms, shower rooms, saunas or outdoors. In the case of failure to comply, all guarantee and warranty claims will become void.

The Aqua+ Laminate Flooring collections are the only exception. EGGER Aqua+ Laminate Flooring can also be installed in bathrooms with normal household use without a floor drain with bath tub or shower tray, where the floor surface is only temporarily and briefly exposed to splashing water. These include private bathrooms, but also hotel bathrooms that are only used in the morning and evening, or kitchens, corridors, entrance areas and apartments in nursing homes.

Prior to installation

If this is not possible, the following alternatives are available:

A) Decoupling:

1. Install the Laminate Flooring over the entire surface and assemble the kitchen unit / built-in cupboard.
2. Decouple the Laminate Flooring surface by sawing between the furniture feet and the skirting panel.
3. Cover by floor profile or leave open (no visible area).

B) Bolt circle drill:

1. Install the Laminate Flooring over the entire surface.
2. Determine the position of the furniture feet, mark them on the laminate flooring and saw them out using a bolt circle drill (\varnothing furniture foot + 16 mm).
3. Assemble the kitchen unit / built-in cupboard.

Planning the first and last row

Prior to installation, the room must be measured to determine whether the width of the first row should be reduced. This is always necessary if the last row would mathematically be narrower than 5 cm and / or to give the first and last row the same width.

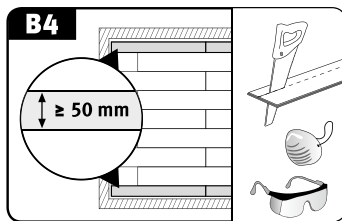

Wall distance and expansion gaps

EGGER Laminate Flooring – like all wood-based floors – are subject to a certain motion behaviour due to changing room climate conditions. Due to this material-specific motion behaviour, edge / wall joints must be installed for all fixed structures such as walls, door frames, pipe penetrations, pillars and stairs. In addition, motion joints must always be installed in the following surface areas and surface sizes:

- door thresholds
- passageways
- angled areas
- for room lengths and / or widths of more than 10 m.

Sufficiently dimensioned wall distance and expansion gaps, with a width of at least 8-10 mm, do not impede the motion of the installed floor surface.

The guiding formula is as follows: 1.5 mm expansion gap (circumferential) per metre of floor surface (for example: 10 m room length = 15 mm wall distance to both walls).

The wall distance and expansion gaps are covered by skirting board and / or floor profiles.

Note: With most types of profile, it is necessary to fit the base (sub-profile) to take the cover profile prior to installing Laminate Flooring.

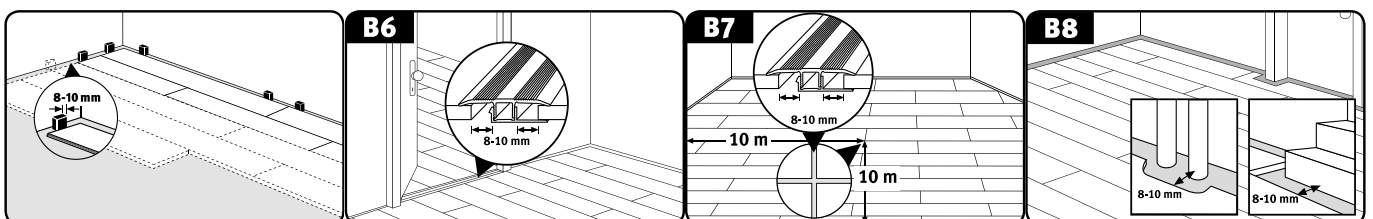

4. Installation

4.1. Basic information

- The installation must be carried out in daylight.
- Review the flooring boards for possible faults prior to and during installation. Flooring boards with visible damage or defects must not be installed.

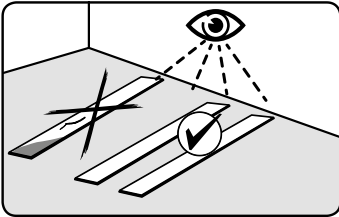

- EGGER Laminate Flooring is installed “floating”, i.e. without fixing (no bonding / screwing etc.) the flooring boards to the subfloor. With floating installation, the individual floor boards are installed using the CLIC*it!* locking system to connect and place the individual boards.
- **Note:** The only exception are the Aqua+ Laminate Flooring collections. These floors can also be bonded over the entire surface (for details see section “Aqua+ Laminate Flooring”).

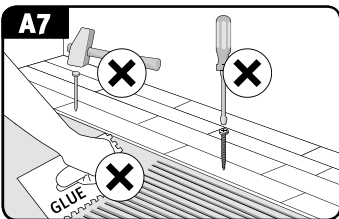

- Make sure that you understand the difference between the groove and tongue on the board.

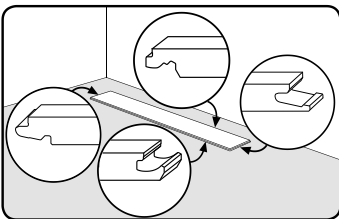

- Start installing in a left-hand corner of the room with both tongue sides of the first panel facing the wall and both grooved sides facing the installer.
- The short ends (header joints) must be staggered at least 20 cm or ≥ 50 cm for the “Long” format.
- In case of products supplied with factory-produced bevel and / or with special design (e.g. tiles decor), ensure the short end (header joint) is even according to the bevel and / or pattern configuration.
- Remaining pieces can be used as the start or end board of each row if they are at least 20 cm long (≥ 50 cm for the “Long” format), and thus the minimum offset of the short ends (header joints) from row to row is maintained.
- In order to prepare the last row of boards for installation, take the board and place it exactly on top of the row before last. By means of a residual board (board width), it is possible to transfer the wall structures to the board within a pre-chosen distance.
- When cutting to size by using a circular, plunge or cross-cut saw, place the floor boards with the decor side facing upwards. When cutting to size by using jigsaw, move it over the back of the board.

Installation

4.2. Installation methods

The installation of EGGER Laminate Flooring with CLIC *it!* installation system can be carried out using 3 different installation methods:

- Method A: angled in at the front and long side board by board
- Method B: angled along the long side and tapped in at the short end (header joint) board by board
- Method C: installation in rows by angling the front and long sides

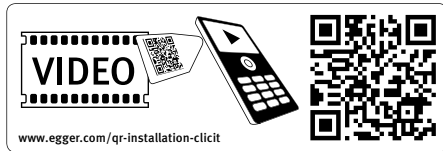

4.2.1. Installation method A

- Place the first board in the left-hand corner of the room so that both tongue sides face the wall (Fig. C1a).
- Join the boards of the first row by angling the front tongue of the board to be installed diagonally from above into the front groove of the already installed board and lay it down with light pressure on the front side (Fig. C1a). The last board in the first row is marked and cut to the required length and installed as specified above.
- Make sure that the boards of the first row are aligned with precision on the long side. It is recommended to place a piece of the flooring as a stop / spacer between the wall and the first row, respectively in the area of the end joints. After the first 2-3 rows have been installed, remove the boards acting as stops, and align the flooring area installed up to this point with the wall, maintaining the distance from the wall and inserting the spacers. (Fig. C1a to C 8a)
- Angle the first board of the second and each subsequent row diagonally from above with the tongue in the groove of the previously installed row and lay it down with light pressure on the long side (Fig. C3a).
- Install all subsequent boards of a row as follows:
 1. Angle the front tongue at an angle from above into the front groove of the previously installed board and lay the board (with light pressure on the front side) as close as possible to the long edge of the installed row (Fig. C4a).
 2. Slightly lift the board to be laid on the long side (Fig. C5a).
 3. Now click the tongue on the long side diagonally from above into the groove of the previous row (push in) and lower the board, thus closing the long side joint (Fig. C6a).

Note: Please note that when lifting and angling the board on the long side, the adjacent board on the left is automatically lifted as well due to the already locked front end.

 4. Make sure that all joints are completely closed, i.e. that no joints are visible. If there are isolated, smaller joints, these can be closed by light, controlled tapping with a tapping block.

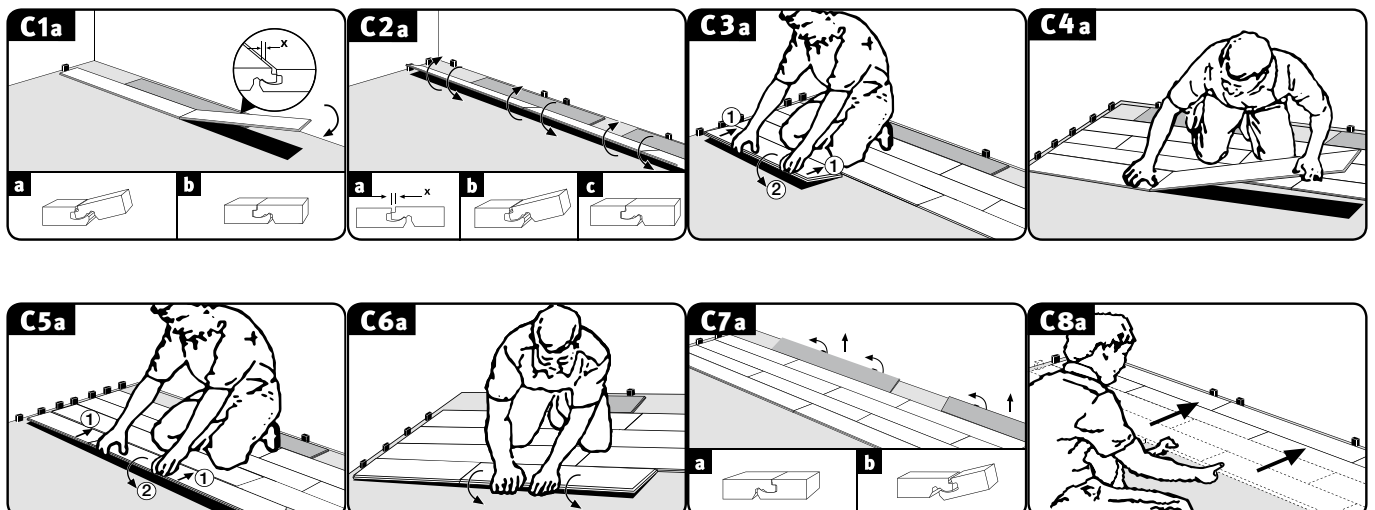

Install all remaining boards as described above, by cutting the length of the first and / or last board of any row to the necessary size.

Installation

4.2.2. Installation method B:

- The boards in the first two rows can be installed simultaneously, which means constantly alternating them whilst complying with the minimum offset of the header joints.

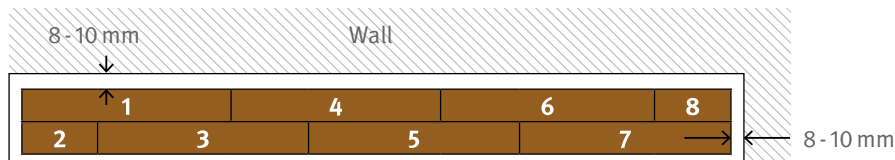

- Board 1 = lay out in a left-hand corner of the room so that both tongue sides face the wall.
- Board 2 = angling the long side of this shortened board.
 - For this purpose, place the longitudinal tongue at a slight angle from above into the longitudinal groove of board 1 and lower board 2.
- Board 3 = angle in on the long side & tap in on the short side (do not hit!).
 - To begin with, place the longitudinal tongue at a slight angle from above into the longitudinal groove of board 1 (Fig. C2b).
 - In this angled position, push board 3 as close as possible to the front edge of board 2 so that the front tongue of board 3 lies on the groove milling of board 2 (Fig. C3b).
 - Then lock the longitudinal joint by lowering board 3. Briefly make sure that the height of the front tongue is not too high above the header joint of board 2 (Fig. C3b).
 - If the height is correct, lock the header joint by lightly tapping horizontally with a hammer and tapping block (Fig. C3b).

Note:

- To adjust the height level, it is recommended to place a flooring board on the long side in the area of the front joint.
- Excessive hammering can lead to damage to the header joint, which may only become apparent later in the course of use.
- Board 4 = opposite longitudinal angling and tapping of the short side as above.
 - Place the longitudinal groove at a slight angle under the longitudinal tongue of board 3 (Fig. C4b).
 - In this angled position, push board 4 as close as possible to the front edge of board 1 so that the front tongue of board 4 lies on the groove milling of board 1 (Fig. C4b).
 - Then lock the longitudinal joint by lowering board 4. Briefly make sure here as well that the height of the front tongue is not too high above the front joints of board 1 (Fig. C4b).
 - If the height is correct, lock the header joint by lightly tapping horizontally with a hammer and tapping block (Fig. C5b).
- Board 5 = longitudinal angling and tapping on the front end (see board 3)
- Board 6 = longitudinal angling and tapping on the front end (see board 4)
- Board 7 = longitudinal angling and tapping on the front end (see board 3)
- Board 8 = longitudinal angling and tapping on the front end (see board 4)
- Install all remaining boards of the first two rows as described above, by cutting the length of the first and / or last board of any row to the necessary size.
- Subsequently, position the first two rows while observing the wall distance to the long side wall and place the spacers.
- Angle the first board of the third and each subsequent row diagonally from above with the tongue in the groove of the previously installed row and lay it down with light pressure on the long side.
- Install all subsequent boards of a row as follows:
 - To begin with, insert the longitudinal tongue diagonally from above into the longitudinal groove of the previous row.
 - In this angled position, push the board as close as possible to the front edge of the left board so that the front tongue of the board to be installed lies on the groove milling of the left board.
 - Then lock the longitudinal joint by lowering the board. Briefly make sure that the height of the front tongue is not too high above the front joint of the left board.
 - If the height is correct, lock the header joint by lightly tapping horizontally with a hammer and tapping block.
 - Install all remaining boards as described above, by cutting the length of the first and / or last board of any row to the necessary size.

Installation

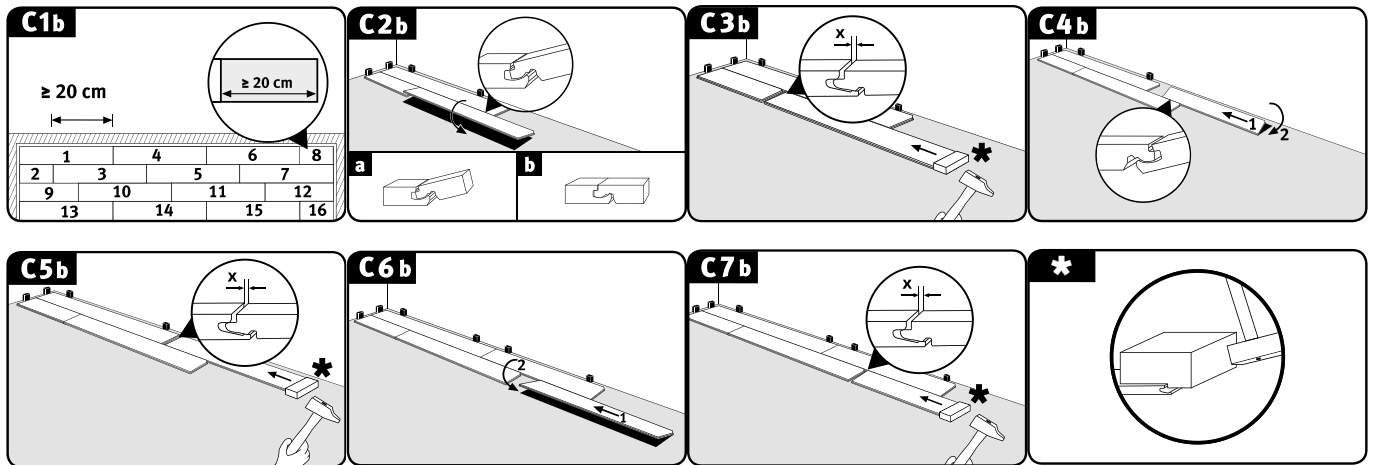

4.2.3. Installation method C

- Place the first board in the left-hand corner of the room so that both tongue sides face the wall (Fig. C1c).
- Join the boards of the first row by angling the front tongue of the board to be installed diagonally from above into the front groove of the already installed board and lay it down with light pressure on the front side (Fig. C1c). The last board in the first row is marked and cut to the required length and installed as specified above.
- Make sure that the boards of the first row are aligned with precision on the long side. It is recommended to place a flooring board as a stop / spacer between the wall and the first row, respectively in the area of the header joints (Fig. C1c to C6c). After the first 2-3 rows have been installed, remove the boards acting as stops, and align the flooring area installed up to this point with the wall, maintaining the distance from the long side wall and inserting the spacers. (Fig. C7c & C8c).
- Install the first board of the second and each subsequent row with the long side tongue over the long side top groove of the previously installed row without closing the locking system (Fig. C3c).
- All subsequent boards of a row are first connected at the front end (Fig. C4c).
 - Angle the front tongue at an angle from above into the front groove of the previously installed board and lay the board (with light pressure on the front side) as close as possible to the long edge of the installed row, so that the tongue lies on the long side top groove of the previous row.
- Then, when all boards of a row are connected at the front end, close the long side locking system (Fig. C5c and C6c).
 - Slightly lift the start board on the long side.
 - Now click the long side tongue, in this angled position and with slight pressure, into the groove of the previous row (push in).
 - Continue this from left to right until the entire row is connected to the previously installed row and lies flat.

Note: Pay attention that the panels are not displaced along the short sides.

 - Make sure that all joints are completely closed, i.e. that no joints are visible. If there are isolated, smaller joints, these can be closed by light, controlled tapping with a tapping block.
- Install all remaining boards as described above, adjusting the length of the first and / or last board of any row if necessary.

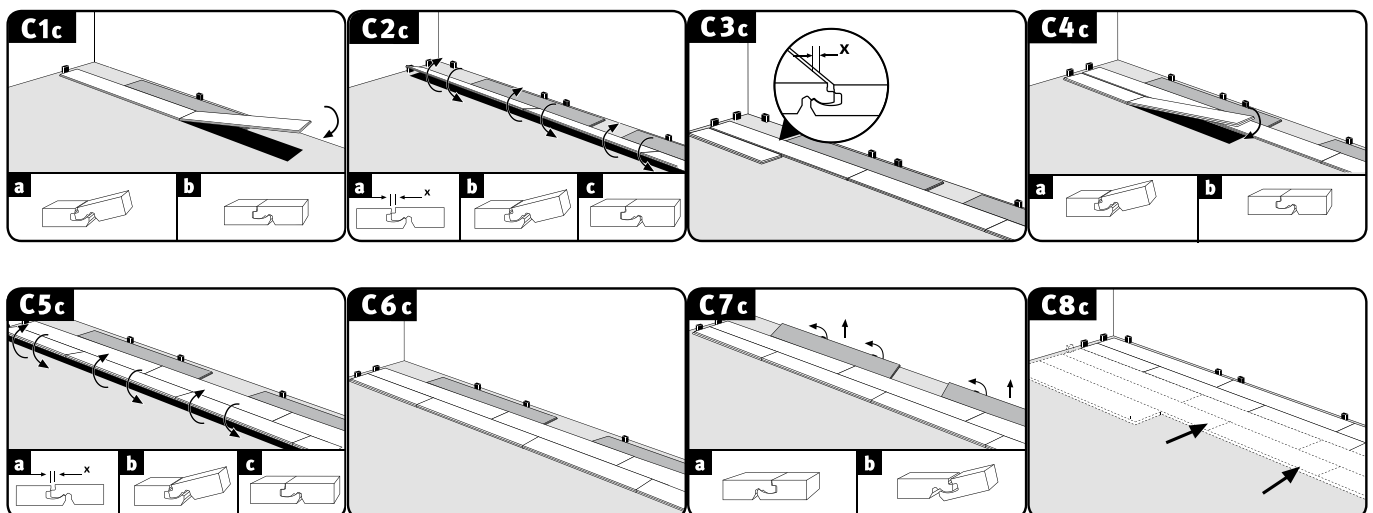

Installation

4.3. Additional installation instructions

Commercial applications of classes 31, 32 and 33

Commercial applications can be expected to be exposed to above-average levels of moisture. For this reason, additional sealing with PVAC glue (D3), is prescribed in these areas (with the exception of Aqua+ products). Apply the sealing glue to the front and long side tongue in such a way that it exits upwards along the entire length of the joint when the boards are joined together. Make sure that the boards below the sealing glue are installed without a gap. Excess sealing glue is easy to remove from the surface immediately or after a short drying period.



Pipes

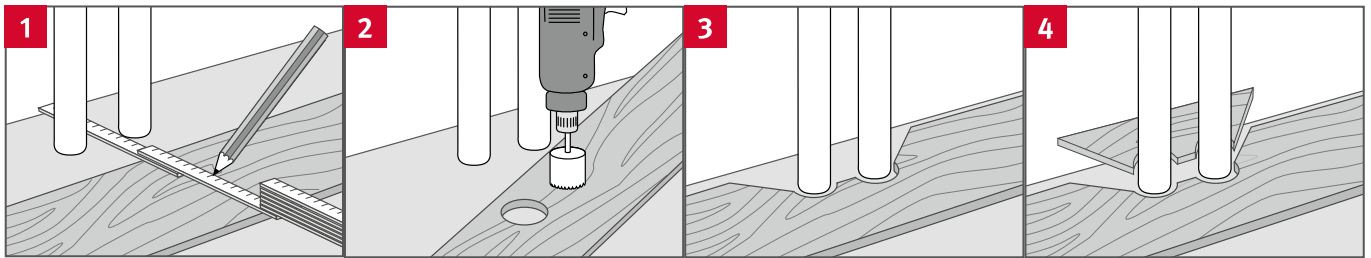

- Measure the position of the pipes and mark it on the panel (allow for edge joint).
- Drill at least 16 mm larger than the diameter of the pipe.
- Saw the holes at a 45° angle.
- Fit and glue the sawn piece.

Installation

Door frames

- If there are wooden door frames, it is recommended to shorten these by the installation height (flooring plus underlay materials) in consultation with the customer.
- Then install the Laminate Flooring underneath the door frame by using the appropriate wall distance. If the installation takes you to such a frame, the respective board can be angled longitudinally and lowered before the frame. Then the board is tapped under the door frame into the header joint with a hammer and tapping block by laying it flat on the floor and locked.

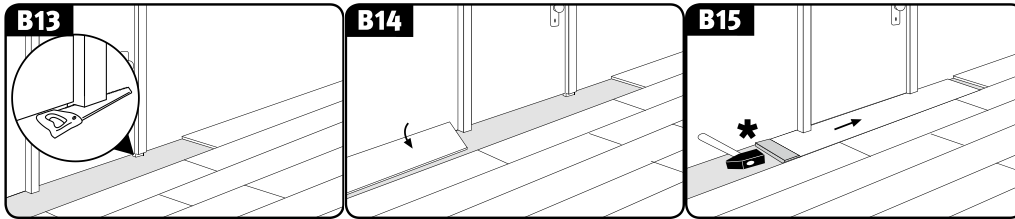

- If the door frame cannot be shortened, a standard PE joint filler profile must be inserted into the surrounding expansion gap (in the area of the door frame) and rubbed / covered with silicone.

Flooring profiles and skirting boards

After finishing the professional installation of the Laminate Flooring, both the necessary flooring profiles and skirting boards are installed. Assembly instructions are included with the accessories.

Removal / dismantling of boards

In order to remove installed boards without destroying them, you first have to unlock the entire row by tilting it and then detach the panels at the short ends while tilted. Proceed with great care in order to avoid damaging the tongue and groove.

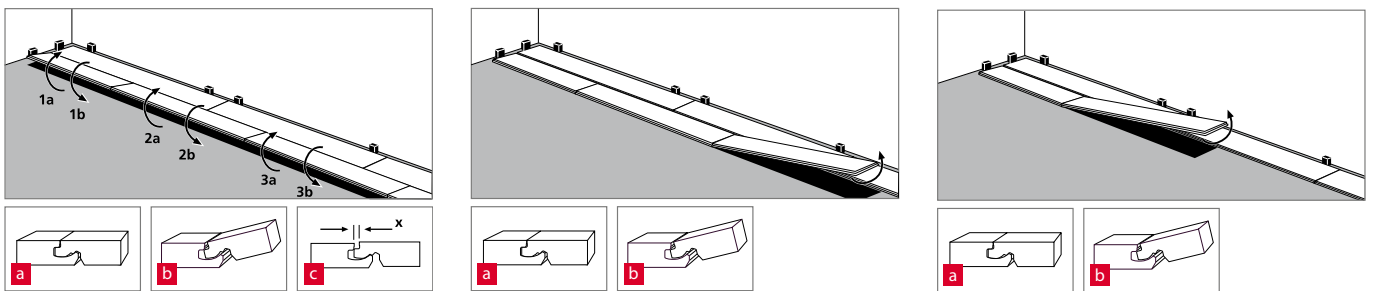

5. Aqua+ Laminate Flooring



EGGER Aqua+ Laminate Flooring* can also:

- Be installed in bathrooms with normal household use without a floor drain with bath tub or shower tray, where the floor surface is only temporarily and briefly exposed to splashing water. These include private bathrooms, but also hotel bathrooms that are only used in the morning and evening, or kitchens, corridors, entrance areas and apartments in nursing homes.
- Be installed by means of full-surface bonding.

*Applications exclude wet areas, locations and / or conditions (such as for example, saunas, steam baths, shower cabins or cells, community laundry rooms and swimming pool areas), areas with permanent and increased moisture or liquid exposure, bathrooms with floor drain, as well as any outdoor area.

5.1. Floating installation in bathrooms

Aqua+ Laminate Flooring is suitable for floating installation in bathrooms on all subfloors listed below if they meet the requirements for installation suitability described under section 2.1.:

- all types of screed including hot water-heated screed
- ceramic tiles.

Furthermore, the subfloor must be properly sealed (see DIN 18534 Waterproofing for indoor applications & water action classes) in order to permanently prevent moisture damage to the construction.

Floor structure for bathroom use:

1. subfloor (as previously named)
2. construction sealing (composite waterproofing, for indoor applications)
3. underlay mats plus sealing off wall connection area
 - Option A: EGGER Silenzio Duo & sealing tape
 - Option B: EGGER Silenzio Easy SD & sealing tape
 - Option C: EGGER Aqua+ Aluflex & sealing tape & EGGER Silenzio Easy
4. EGGER Aqua+ Laminate Flooring

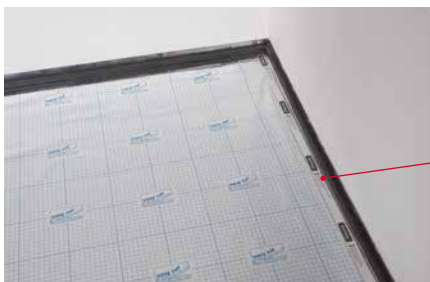

moisture barrier & sealing tape



Aqua+ Laminate Flooring

The floating installation of Aqua+ Laminate Flooring in bathrooms is carried out using one of the methods described in section 4.2., whereby the individual floor boards are locked using the CLIC *it!* connection.

Note!

- It is absolutely necessary to ensure the full-surface installation of the system-specific moisture protection film and to use a tape to seal off the wall connection areas in a trough shape

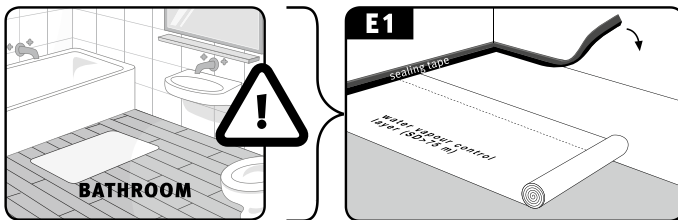

- Only transition, adjustment and end profiles made of aluminium may be used. The joint between profile and wall must be sealed in a waterproof manner with an elastic joint seal.

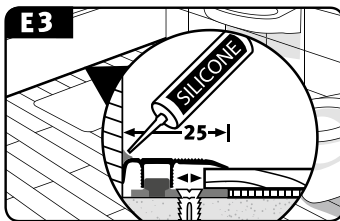

5.2. Full-surface bonding

Installation by means of full-surface bonding offers, among others, the following advantages:

- stable and compact floor surface with reduced motion behaviour and optimised installation height
- large surface installation, given that only functional structural joints must be expanded into the top floor (EGGER Aqua+ Laminate Flooring) via a motion profile
- significant improvement of walking sound (ambient sound)
- optimised performance on underfloor heating due to the reduced heat conductivity.

Aqua+ Laminate Flooring is suitable for installation through full-surface bonding on all subfloors listed below if they meet the requirements for installation suitability described under section 2.1.

1. Standard application (dry room conditions)

- all types of screed including hot water-heated screed
- OSB and chipboard structures
- fibreboards
- ceramic tiles (system-specific base coat / filling of the tiles is required)

Floor structure for standard application:

- 1) subfloor (as previously named)
- 2) system-specific base coat / filling
- 3) adhesive (for approved adhesives please see www.egger.com)
- 4) EGGER Aqua+ Laminate Flooring

2) Bathroom application (wet room conditions)

- all types of screed including hot water-heated screed
- ceramic tiles (system-specific base coat / filling of the tiles is required)

Aqua+ Laminate Flooring

Floor structure for bathroom use:

- 1) subfloor (as previously named)
- 2) system-specific base coat / filling & composite waterproofing
- 3) adhesive (for approved adhesives please see www.egger.com)
- 4) EGGER Aqua+ Laminate Flooring

Aqua+ Laminate Flooring can be bonded over the entire surface both in private living areas and the commercial sector. For full-surface bonding, the installation is carried out as described in section 4.2.2 “Method B”, i.e. the individual floor boards are locked on the long side, placed into the adhesive bed and tapped in at the short end (header joint), so that the full surface of the board reverse is covered.

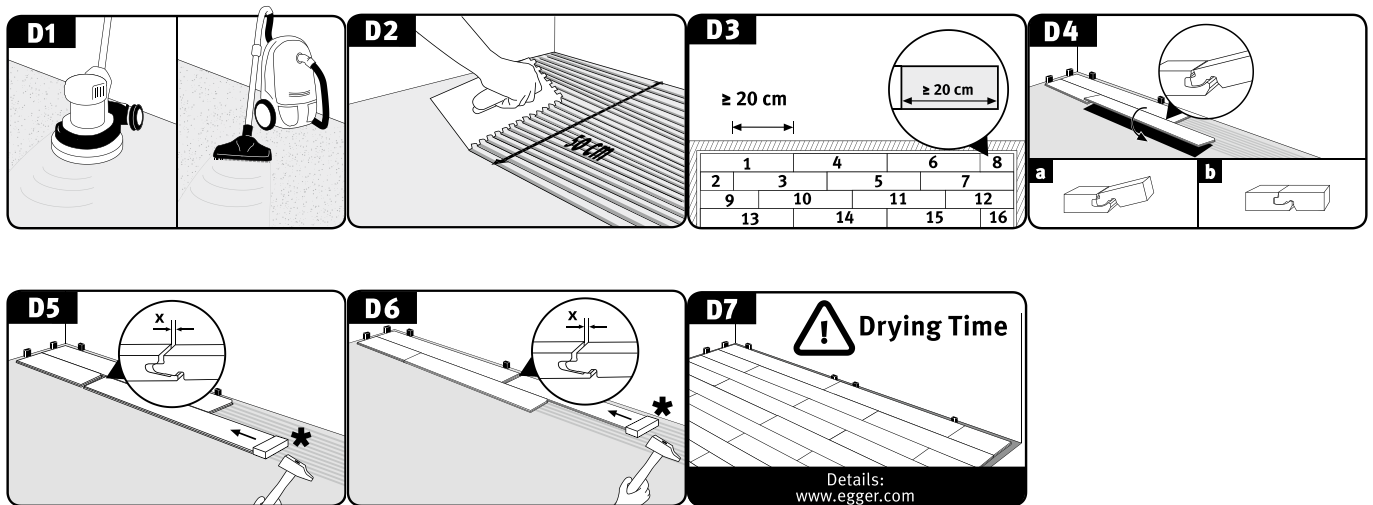

As a general rule:

- Full-surface bonding should be carried out by a specialist (professional floor installer).
- Faulty placement in the adhesive bed must be avoided, if the evenness of the subfloor as required for installation is not achieved, a system-specific base coat and / or filling must be applied without fail. For tiled floors, a system-specific base coat and filler are always required.
- Screeds must always be sanded and vacuum-cleaned using an industrial vacuum cleaner.
- In bathrooms, the subfloor must be properly sealed prior to installing the Aqua+ Laminate Flooring to permanently prevent moisture damage to the construction.
- An adhesive approved by the adhesive manufacturer must be used. All specifications provided by the adhesive manufacturer, for example trowel serration, fitting and setting times, must be observed. In the case of failure to comply, all guarantee and warranty claims will become void. An overview of approved adhesives is available at www.egger.com.
- Depending on the subfloor, the notched trowel must be replaced by a new one every 30-50 m² at the very most.
- EGGER Holzwerkstoffe Wismar GmbH & Co. KG is not liable for the correct use and processing of the adhesive system.
- In the case of full-surface installation of Aqua+ Laminate Flooring, motion profiles only need to be built into door thresholds / passageways if there is a functional joint included in the structure. Both areas must overlap in space, as functional structural joints must be expanded into the top floor.
- The maximum area size for full-surface bonding is determined by the functional structural joints. In this regard, the following recognised rule of the trade applies: All functional construction joints located in the subfloor may never be subjected to force-fitting closing and must be expanded into the top floor.
- Prior to installation contraction joints in the sub floor area, also in door passageway must be sealed force-fitted (e.g. slice/grind the contraction joint, place screed clamp into the cross-cut and fill with synthetic resin) when the screed is hardened. Contraction joints should not be taken into the top floor.
- It is the planner's responsibility to provide all information about the positioning and function of the respective joints particularly in regards to expansion joints. Note: Failure to comply with the rules for expansion joints can lead to irreparable damage.

Aqua+ Laminate Flooring

Attention!

The drying and hardening time of the respective adhesive must be observed without fail, before the installed Aqua+ Laminate Flooring surface is approved for use.

6. Cleaning and maintenance of EGGER Laminate Flooring

Most dirt can be avoided by having appropriate doormats or walk off zones in entrance areas. For the rest of the floor, it is recommended to use the brush attachment on the vacuum cleaner. Depending on the frequency of use and amount of dirt, you should also wipe the floor with a damp cloth or mop regularly. Take care to also clean the bevels in a longitudinal direction. For optimum cleaning we recommend Clean-it, our EGGER system-specific floor cleaner.

- Entrance areas are to be equipped with a reasonably sized walk off zone / door mat.
- For commercial applications where the flooring area directly adjoins the outdoor area, a recessed and reasonably sized walk off zone is to be fitted in the flooring structure.
- Lift furniture when moving rather than pushing or dragging a blanket or towel under the furniture legs may be acceptable if sliding.
- Attach felt pads to the feet of furniture, including chairs and tables. Clean these regularly, check for proper functionality and replace if required.
- On office chairs and all other equipment pieces on rollers, soft chair castors (type W) are to be used. If suitable chair castors are not available, a floor protection mat must be used.
- The office chair and furniture castors are to be cleaned at regular intervals, tested for functionality and replaced if necessary.
- Use the hard floor nozzle (brush accessory) when vacuum cleaning. Rotating beater bars must be deactivated / removed.
- Only clean the laminate flooring with a damp cloth. Do not use a dripping wet mop / cloth on the flooring or pour liquids directly on the flooring.
- Immediately remove all liquid spills, stagnant moisture fluids (humidity). Do not allow moisture / liquids to remain on the floor longer than necessary.
- Do not allow splashing water (wet) or moisture standing on the Laminate Flooring to dry off, but wipe it up and dry it off as quickly as possible.
- Cleaning Laminate Flooring with steam cleaners is not permitted and should not be done, except for designated Aqua+ Laminate Flooring*.
- Beater bars should be disabled or removed.
- Do not use grinding, scouring and polishing machines, scrubbing brushes, high-pressure cleaners or similar products.
- Do not use cleaning products that may leave a residue. We recommend Clean-it, our EGGER system-specific floor cleaner.
- Never use abrasive, steel wool or scouring agents on the laminate flooring.
- It is unnecessary to apply wax or polish to laminate flooring. The use of wax or polish will void all guarantees and warranties.
- It is unnecessary to apply sealant to laminate flooring. The use of sealant will void all guarantees and warranties.

*Only Aqua+ Laminate Flooring may be cleaned with commercially available steam cleaners. When using a steam cleaner, it is necessary to keep the machine constantly moving. The steam cleaner should only be filled and operated with clean water. Do not add cleaning products or other additives.

Failure to comply with the cleaning and maintenance instructions listed here invalidates all warranty and guarantee claims.

No matter how hard wearing your floor is, a piece of flooring may still get damaged. If the damage is slight, use the system specific EGGER repair paste Decor Mix & Fill or hardwax to repair. More severely damaged panels can be easily replaced by a professional fitter. Separate instructions are available upon request.

www.egger.com

EGGER Holzwerkstoffe Wismar

GmbH & Co. KG

Am Haffeld 1

23970 Wismar

Germany

T +49 3841 301-0

F +49 3841 301-20222

flooring@egger.com

EGGER Drevprodukt Gagarin

Ezhvinsky proezd, 1

215010 Gagarin

Oblast Smolensk

Russia

T +7 48135 79-300

F +7 48135 79-311

info-ru@egger.com