

Smartloc 1 standard

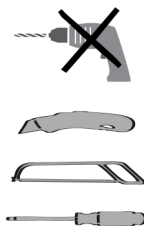

1. A / B?

A1



A2



CLICK

B1



B2

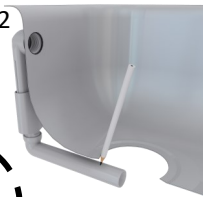

CLICK

A3



A4

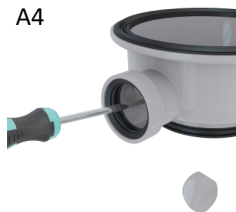

→A5

B3



B4

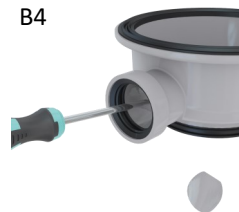

→B5

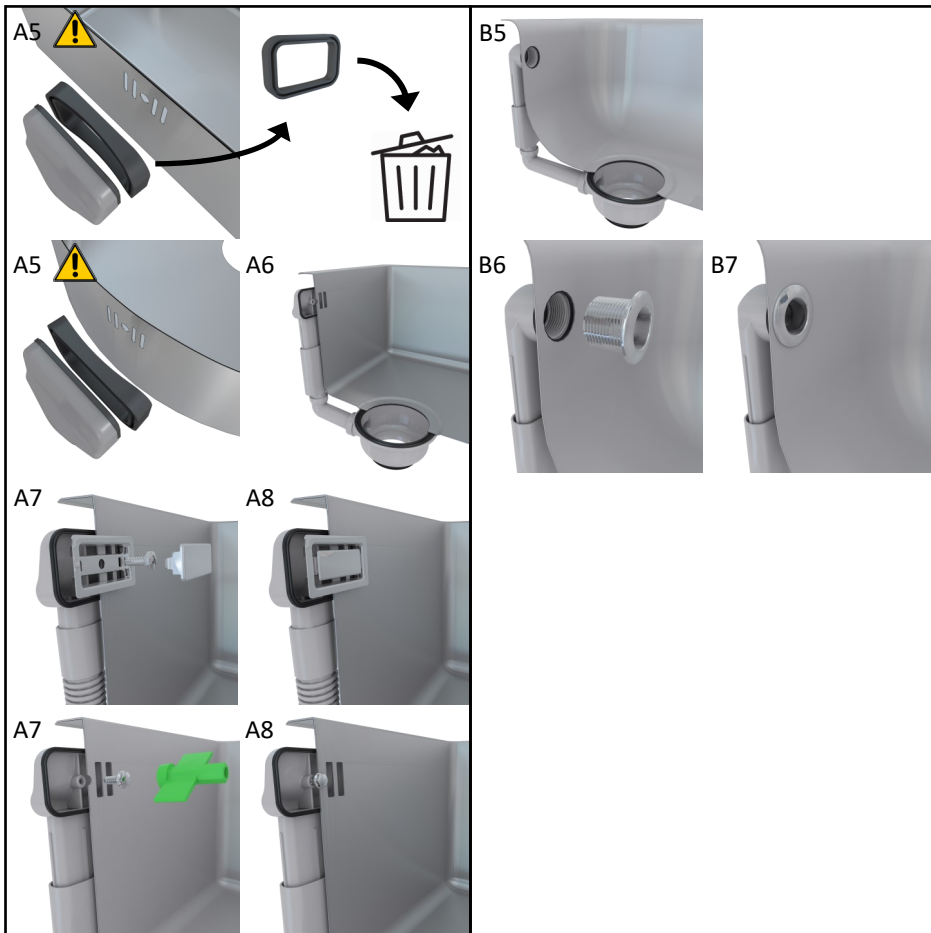

2.

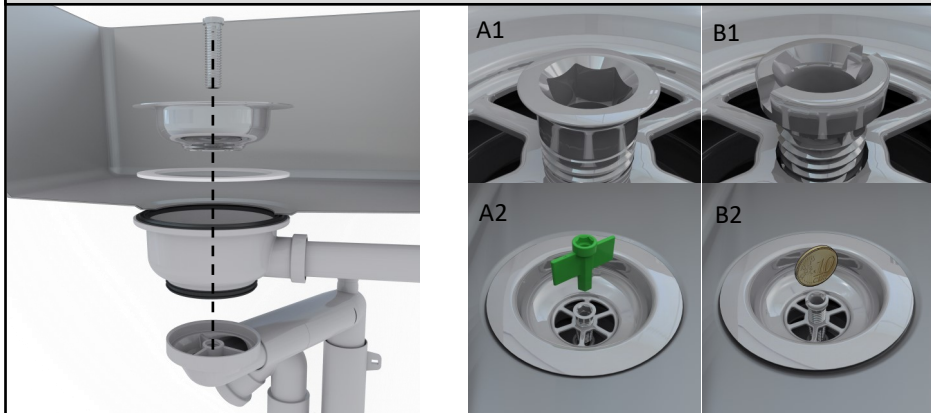

3.



4.

1.

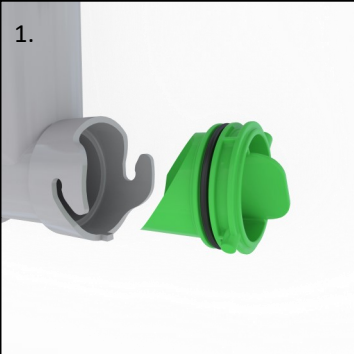

2.

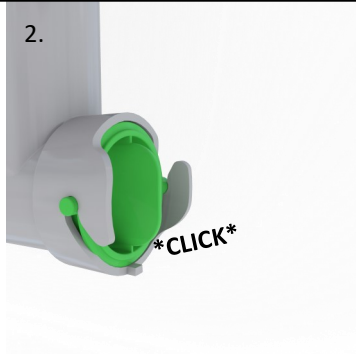

5. A / B?

A1.

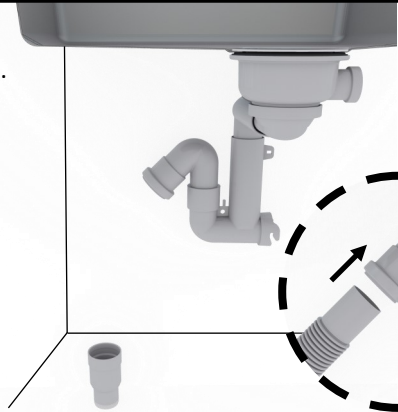

A2.

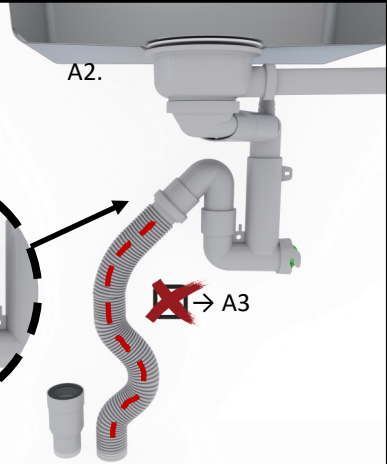

A3.

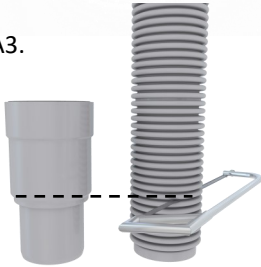

A4.



A5.

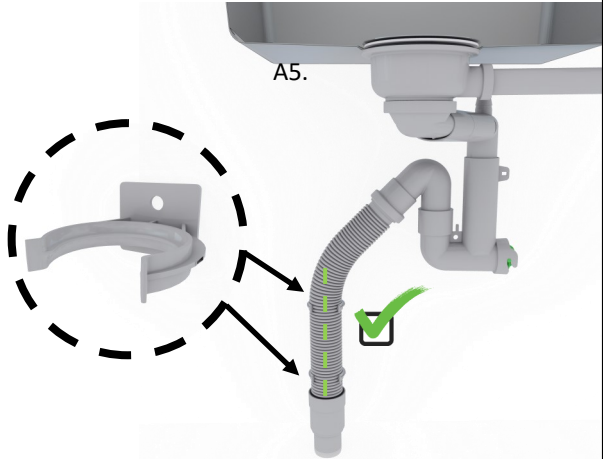

B1

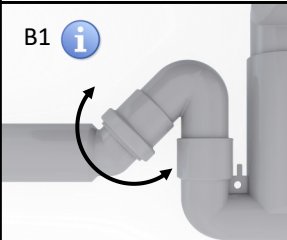

B1

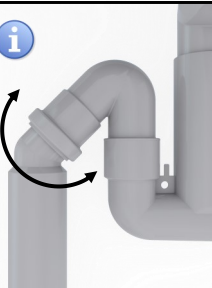

6.



INFO

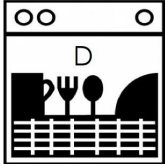

SERVICE

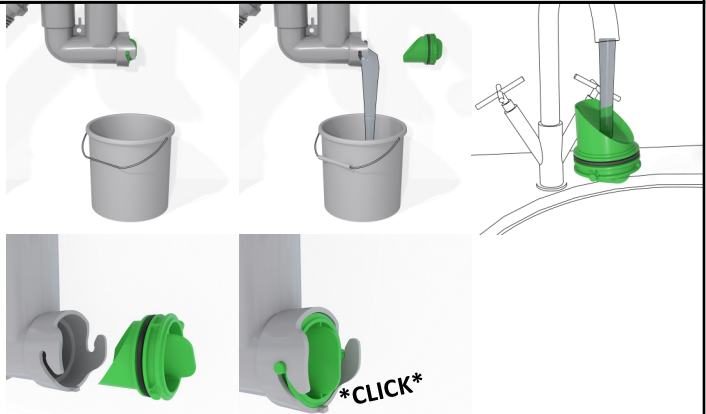

INFO

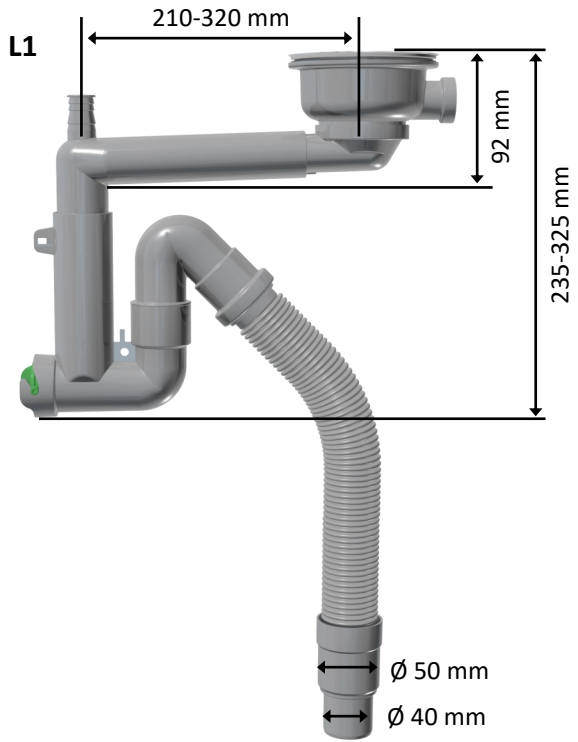

L2 info

